



Omnivision VHS

Panasonic

Combination VCR Operating Instructions

Models No. PV-C2540 / PV-C2580



As an ENERGY STAR® Partner, Matsushita Electric Corporation of America has determined that this product or product model meets the ENERGY STAR® guidelines for energy efficiency.



Easy Taping.



Please read these instructions carefully before attempting to connect, operate or adjust this product. Please save this manual. Spanish Quick Use Guide is included. (Guía para rápida consulta en español está incluida.)

LSQT0199A

For assistance, call 1-800-211-PANA(7262)

Getting Started

Basic Operation

Advanced Operation

For Your Information

Important Safeguards and Precautions

READ AND RETAIN ALL SAFETY AND OPERATING INSTRUCTIONS. HEED ALL WARNINGS IN THE MANUAL AND ON UNIT

INSTALLATION

1 POWER SOURCE CAUTION

Operate only from power source indicated on unit or in this manual. If uncertain, have your Electric Utility Service Company or Video Products Dealer verify your home power source.

2 POWER CORD PLUG

For safety, this unit has a polarized type plug (one wide blade), or a three-wire grounding type plug. Always hold the plug firmly and make sure your hands are dry when plugging in or unplugging the AC power cord. Regularly remove dust, dirt, etc. on the plug.

POLARIZED PLUG CAUTION:

The plug fits into outlet one way. If it cannot be fully inserted, try reversing it. If it still will not fit, have an electrician install the proper wall outlet. Do not tamper with the plug.

GROUNDING PLUG CAUTION:

The plug requires a three-hole grounding outlet. If necessary, have an electrician install the proper outlet. Do not tamper with the plug.

3 POWER CORD

To avoid unit malfunction, and to protect against electrical shock, fire or personal injury:

- Keep power cord away from heating appliances and walking traffic. Do not rest heavy objects on, or roll such objects over the power cord.
- Do not tamper with the cord in any way.
- An extension cord should have the same type plug (polarized or grounding) and must be securely connected.
- Overloaded wall outlets or extension cords is a fire hazard.
- Frayed cords, damaged plugs, and damaged or cracked wire insulation are hazardous and should be replaced by a qualified electrician.

4 DO NOT BLOCK VENTILATION HOLES

Ventilation openings in the cabinet release heat generated during operation. If blocked, heat build-up may result in a fire hazard or heat damage to cassettes.

For your protection:

- Never cover ventilation slots while unit is ON, or operate unit while placed on a bed, sofa, rug, or other soft surface.
- Avoid built-in installation, such as a book case or rack, unless properly ventilated.

5 AVOID EXTREMELY HOT LOCATIONS OR SUDDEN TEMPERATURE CHANGES

Do not place unit over or near a heater or regulator, in direct sunlight, etc. If unit is suddenly moved from a cold place to a warm place, moisture may condense in unit and on the tape causing damage.

6 TO AVOID PERSONAL INJURY

- Never place unit on support or stand that is not firm, level, and adequately strong. The unit could fall causing serious injury to a child or adult and damage to the unit.
- Move any appliance and cart combination with care. Quick stops, excessive force, and uneven surfaces may cause objects to overturn.
- Carefully follow all operating instructions.



OUTDOOR ANTENNA INSTALLATION

1 SAFE ANTENNA AND CABLE CONNECTION

An outside antenna or cable system must be properly grounded to provide some protection against built up static charges and voltage.

Section 810 of the National Electrical Code, ANSI/NFPA 70 (in Canada, part 1 of the Canadian Electrical Code) provides information regarding proper grounding of the mast and supporting structure, grounding of the lead-in wire to an antenna discharge unit, size of grounding conductors, location of antenna discharge unit, connection to grounding electrodes, and requirements for the grounding electrode.

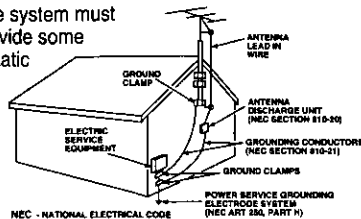

2 KEEP ANTENNA CLEAR OF HIGH VOLTAGE POWER LINES OR CIRCUITS

Locate an outside antenna system well away from power lines and electric light or power circuits so it will never touch these power sources should it ever fall. When installing antenna, absolutely never touch power lines, circuits or other power sources as this could be fatal.

USING THE UNIT

Before unit is brought out of storage or moved to a new location, refer again to the INSTALLATION section of these safeguards.

1 KEEP UNIT WELL AWAY FROM WATER OR MOISTURE,

such as vases, sinks, tubs, etc.

2 IF EXPOSED TO RAIN, MOISTURE, OR STRONG IMPACT,

unplug unit and have it inspected by a qualified service technician before use.

3 ELECTRICAL STORMS

During a lightning storm, or before leaving unit unused for extended periods of time, disconnect all equipment from the power source as well as the antenna and cable system.

4 WHEN UNIT IS PLUGGED IN:

• DO NOT OPERATE IF:

- liquid has spilled into unit.
- unit was dropped or otherwise damaged.
- unit emits smoke, malodors, or noises.

Immediately unplug unit, and have it inspected by a service technician to avoid potential fire and shock hazards.

- Never drop or push any object through openings in unit. Touching internal parts may cause electric shock or fire hazard.
- Keep magnetic objects, such as speakers, away from unit to avoid electrical interference.

5 USING ACCESSORIES

Use only accessories recommended by the manufacturer to avoid risk of fire, shock, or other hazards.

6 CLEANING UNIT

Unplug unit. Use a clean, dry, chemically untreated cloth to gently remove dust or debris. DO NOT USE cleaning fluids, aerosols, or forced air that could over-spray, or seep into unit and cause electrical shock. Any substance, such as wax, adhesive tape, etc. may mar the cabinet surface. Exposure to greasy, humid, or dusty areas may adversely affect internal parts.

SERVICE

1 DO NOT SERVICE PRODUCT YOURSELF

If, after carefully following detailed operating instructions, the unit does not operate properly, do not attempt to open or remove covers, or make any adjustments not described in the manual. Unplug unit and contact a qualified service technician.

2 REPLACEMENT OF PARTS

Make sure the service technician uses only parts specified by the manufacturer, or have equal safety characteristics as original parts. The use of unauthorized substitutes may result in fire, electric shock, or other hazards.

3 SAFETY CHECK AFTER SERVICING

After unit is serviced or repaired, request that a through safety check be done as described in the manufacturer's service literature to insure video unit is in safe operating condition.

Safety Precautions/Mesures de sécurité

Warning: To prevent fire or shock hazard, do not expose this equipment to rain or moisture.

Caution: To prevent electric shock, match wide blade of plug to wide slot, fully insert.

Avertissement: Afin de prévenir tout risque d'incendie ou de chocs électriques, ne pas exposer cet appareil à la pluie ou à une humidité excessive.

Attention: Pour éviter les chocs électriques, introduire la lame la plus large de la fiche dans la borne correspondante de la prise et pousser jusqu'au fond.

This video recorder, equipped with the HQ (High Quality) System, is compatible with existing VHS equipment.

Only use those tapes with the **VHS** mark. It is recommended that only cassette tapes that have been tested and inspected for use in 2, 4, 6, and 8 hour VCR machines be used.

This television receiver provides display of television closed captioning in accordance with §15.119 of the FCC rules.

FCC WARNING: Any unauthorized changes or modifications to this equipment would void the user's authority to operate.

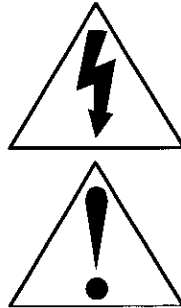
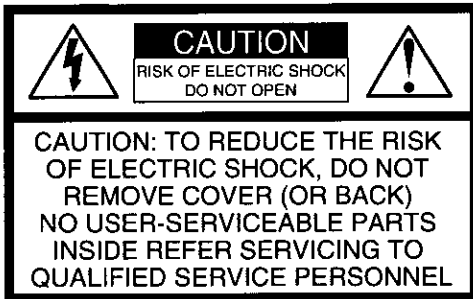

This symbol warns the user that uninsulated voltage within the unit may have sufficient magnitude to cause electric shock. Therefore, it is dangerous to make any kind of contact with any inside part of this unit.

This symbol alerts the user that important literature concerning the operation and maintenance of this unit has been included. Therefore, it should be read carefully in order to avoid any problems.

Table of Contents

To
Start!

Important Safeguards and Precautions ...	2
Before Using	6
• Accessories	6
• Loading the Batteries	6
• Record/Playback Time ...	6
• Prevent Accidental Tape Erasure	6

Use
Now!

TV Operation	10
(Main Operation, NIGHT (NITE) Mode, Using the 100 Key, Rapid Tune, Audio Mute, Phones, SELF-DEMO Mode)	
MTS Broadcast / TV Stereo System (For Model PV-C2580 only)	11
(Stereo/SAP/Mono broadcast, Select Audio Mode for TV Viewing)	

Enjoy
more!

Timer Recording	14 ~ 15
(Main Operation, Cancel, Replace or Clear Program Contents)	
Timer Program using VCR Plus+® System	16 ~ 19
• Cable Box Setup	17
• VCR Plus+ Channel Setup	18
• VCR Plus+ System Programming ...	19
TV Timer Features	20 ~ 21
• ON-TIMER with Alarm	20
• SLEEP TIMER	21
• INSTANT ALARM	21
Closed Caption System	22 ~ 23
• Closed Caption Mode Feature ..	22
• Caption On Mute Feature	23
Tape Operation	24 ~ 27
• Commercial Skip	24
• Program End Search	24
• Tape Position	24
• Repeat Play	25
• Zero Search	25
• Auto Operation Functions ..	25
• VHS Index Search System ..	26, 27

Other
Information!

Reset Language, Channels, Clock ...	46
On-Screen Display (OSD)	47
Unit Information	48
Before Requesting Service	49

Connections	7
• Outdoor Antenna Connections	7
• DSS/Cable box Connections	7

One Time Setup	8 ~ 9
(Language, Channel, Clock)	

Playback a Tape	12
(Main Operation, Forward or Reverse Search, Still Picture, Slow Motion, Frame by Frame Advance, Features for a Quality Picture)	

Record On a Tape	13
(Main Operation, One Touch Recording(OTR), Selecting Input Mode)	

Special VCR Features	28 ~ 32
• Channel Caption	28, 29
• Time Stamp	30, 31
• Weak Signal Display ON/OFF	32
• VCR Lock	32

Copy Your Tapes (Dubbing)	33
--	-----------

FM Radio	34 ~ 35
• FM Radio Setup	34
• FM ANTENNA Setup	34
• Using FM Radio	35
• To select Audio Mode for FM Radio (For Model PV-C2580 only)	35

FM Transmitter (For Model PV-C2580 only)	36
(FM Transmitter Carrier Frequency Setup, FM Transmitter Setup, Speaker with FM Transmitter Setup)	

Picture Adjustment	37
---------------------------------	-----------

V-Chip Control Feature	38 ~ 41
• Enter Secret Code	38
• Setup US MOVIES Ratings	39
• Setup US TV PROGRAMS Ratings ..	40
• Blocking Message	41

Cable Box Universal Remote Control Feature	42 ~ 43
• The Universal Remote Control Setup	42
• Using the Universal Remote Controls	42
• Remote Warning ON/OFF	43
• DSS/Cable Box Brand Code Numbers	43

Audio Feature (For Model PV-C2580 only)	44 ~ 45
--	----------------

Service Center List	50
----------------------------------	-----------

Spanish Quick Use Guide	51 ~ 53
--------------------------------------	----------------

Location of Controls	54 ~ 55
-----------------------------------	----------------

Warranty	Back Cover
-----------------------	-------------------

Before Using

Congratulations

on your purchase of one of the most sophisticated and reliable products on the market today. Used properly, it will bring you and your family years of enjoyment. Please fill in the information below. The serial number is on the tag located on the back of your unit.

Date of Purchase _____
 Dealer Purchased From _____
 Dealer Address _____
 Dealer Phone No. _____
 Model No. _____
 Serial No. _____

Accessories

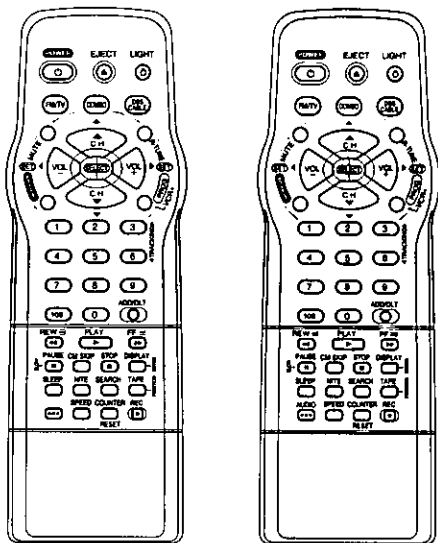

- Remote Control LSSQ0240 (PV-C2540) Remote Control LSSQ0198 (PV-C2580)

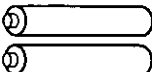
- Batteries 2 "AA" 

To order accessories, call toll free 1-800-332-5368.

Record/Playback Time

Only use tapes with the **VHS** mark in this unit.

Tape Speed Setting	Type of Video Cassette		
	T60	T120	T160
SP (Standard Play)	1 Hour	2 Hours	2 Hours 40 Minutes
LP (Long Play)	2 Hours	4 Hours	5 Hours 20 Minutes
SLP (Super Long Play)	3 Hours	6 Hours	8 Hours

Loading the Batteries

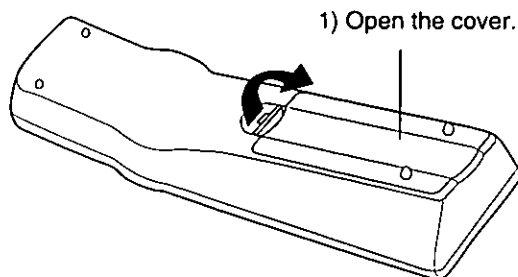

2) Insert batteries as marked.

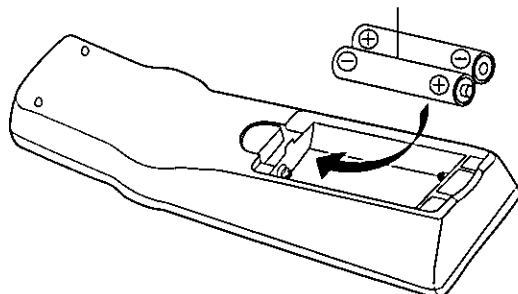

3) Close the cover.

- Battery replacement caution**
- Do not mix old and new batteries.
 - Do not mix alkaline with manganese batteries.

Prevent Accidental Tape Erasure

Break off the tab to protect.

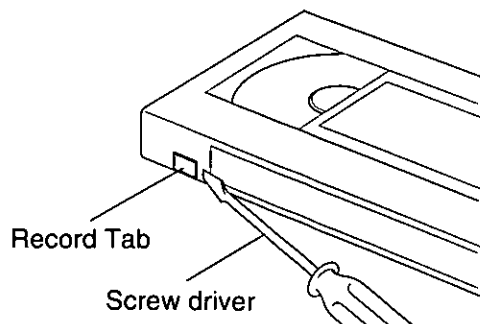

To record again.

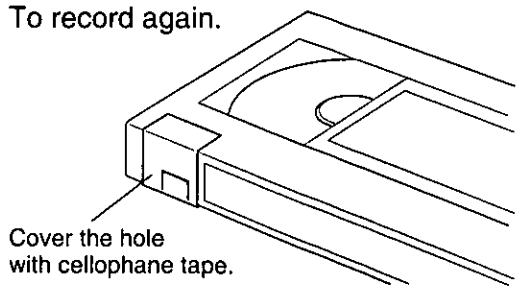

Outdoor Antenna Connection

Unhook the antenna from your previous TV or VCR and connect it to the back of the unit as shown in the diagram.

If your antenna system has separate UHF and VHF lead-ins, you need a UHF/VHF Band Mixer (not supplied.)

WARNING:

When using "Nut type" RF coaxial cables, tighten with fingers only. Overtightening may damage terminals.

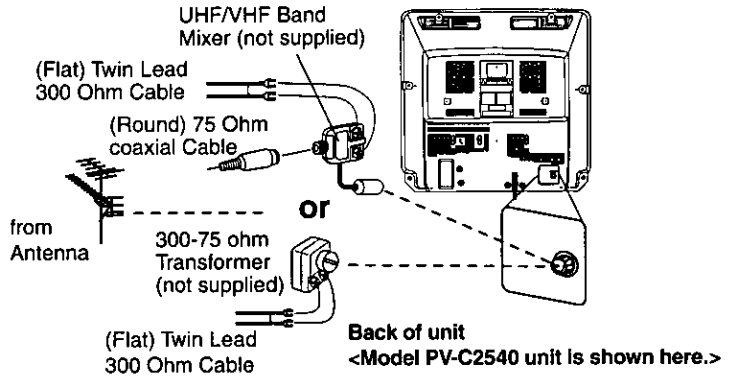

DSS/Cable box Connections

Without a Cable Box

You can;

- record or view unscrambled channels.

You cannot;

- record or view scrambled channels.
- view a channel other than the one selected for any type of recording.

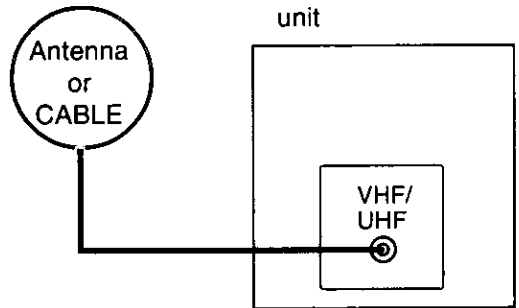

With a Cable Box

You can;

- record or view any channel including scrambled channels.

NOTE: Channel selection must be made at the cable box.

You cannot;

- view a channel other than the one selected for any type of recording.
- do a Timer recording of a channel unless you select it at the cable box.

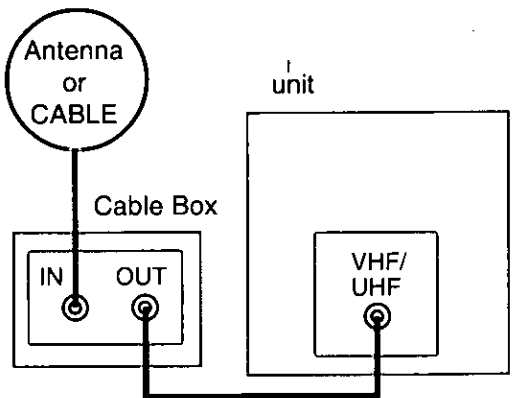

Note to CABLE System Installer

This reminder is provided to call the CABLE (Cable TV) System Installers attention to Article 820-40 of the NEC that provides guidelines for proper grounding and, in particular, specifies that the cable ground shall be connected to the grounding system of the building, as close to the point of cable entry as practical.

With a DSS Receiver

You can;

- record or view any channel including scrambled channels.

NOTE: Channel selection must be made at the DSS Receiver.

You cannot;

- view a channel other than the one selected for any type of recording.
- do a Timer recording of a channel unless you select it at the DSS box.

NOTE: The DSS receiver must be turned off to view programs from a cable box or antenna. See the DSS manual for details.

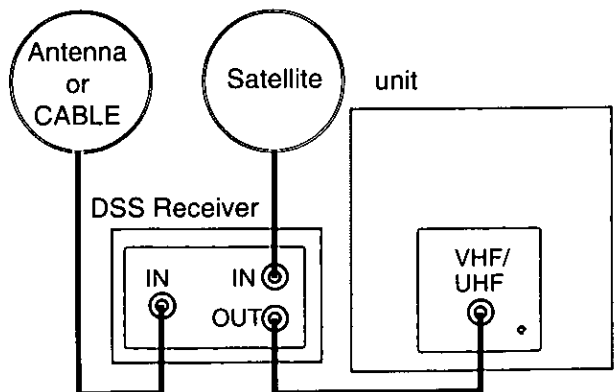

One Time Setup

When the unit is turned on the first time, setup mode is entered automatically.



Press **POWER*** on the remote or unit.

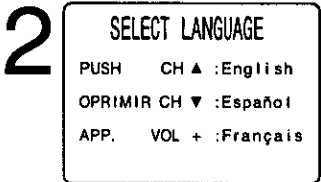

Select the language.

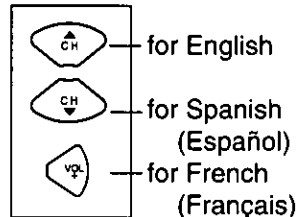

- If wrong language is set, complete "Reset all unit Memory Functions" steps page 48.
- If you use a cable box, it must be left on.

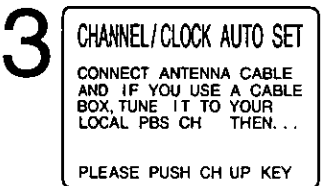

Start Channel Auto Set and Clock Auto Set.

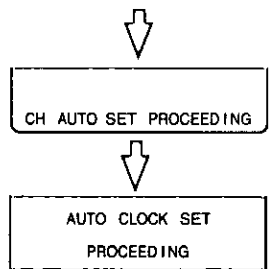
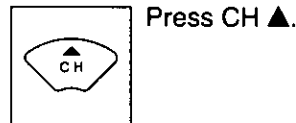

Case 1 (Setup completed)

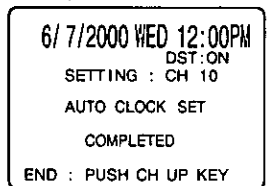

Press CH ▲ to exit.

- If your area observes daylight saving time, but you would like to turn the DST feature off, complete the "To Set or Reset the Clock" step on page 46 and set DST : OFF.

- If your area observes daylight saving time and DST is set to ON, but the time is incorrect; complete the Time Zone Adjust steps on the next page.

Process of Setup

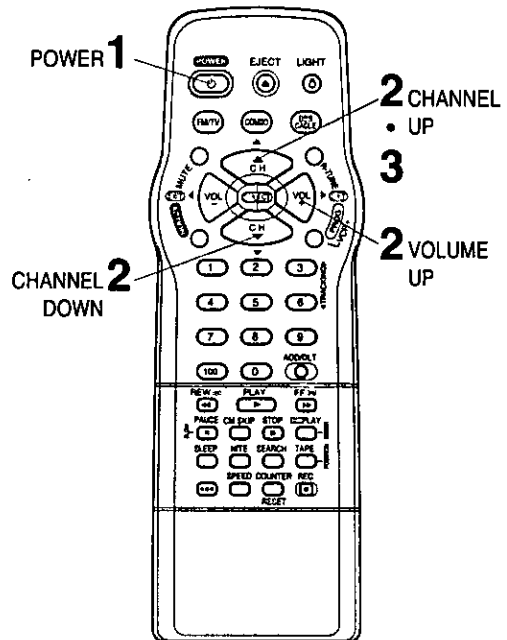

Model PV-C2540 remote is shown here.

Case 2 (Setup incomplete)

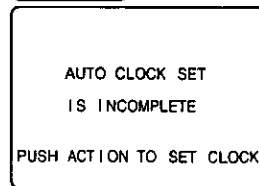

See Case 2 next page.

IMPORTANT NOTE FOR AUTO CLOCK SET

- Auto clock set is performed the first time when the unit is turned off each day. If used, a cable box must be left on and tuned to the PBS channel at the time the unit power is turned off if you want auto clock set to be done.
- If using a DSS receiver, it must be turned off for auto clock set.
- If a Cable Box or DSS receiver is connected to the unit via Audio/Video Jacks, an RF coaxial cable must also be connected for auto clock set and channel auto set features.
- If for any reason the time is changed manually, automatic time correction will not occur.

• Important: if the remote control POWER, CH Up/Down, ACTION, PROG/VCR+, DISPLAY, SEARCH, R-TUNE, FM/TV, or ADD/DLT button does not work when pressed, press COMBO button on the remote and try the button again.

Case 1 Set TIME ZONE ADJUST.

1  **Display MAIN MENU.**
Press ACTION.

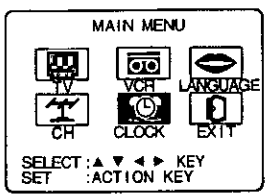
2  **Display SET CLOCK screen.**
1) Press ▲▼◀▶ to select "CLOCK"
2) Press ACTION to display.

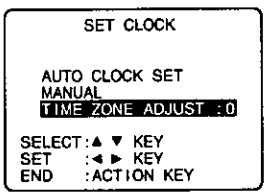
3  **Select TIME ZONE ADJUST.**
1) Press ▲▼ to select.
2) Press ◀▶ to subtract or add hour(s) as necessary.

4  **End setup.**
Press ACTION twice.
• TIME ZONE ADJUST returns to "0" if clock is set manually.

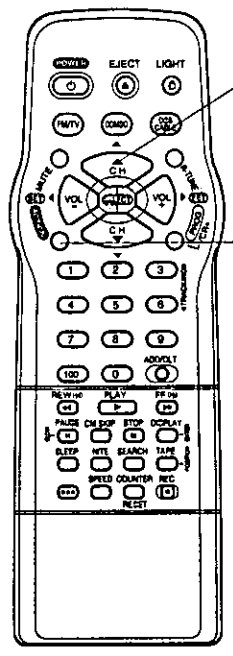

Model PV-C2540 remote is shown here.

Case 2 Clock Setup is Incomplete Set the clock manually.

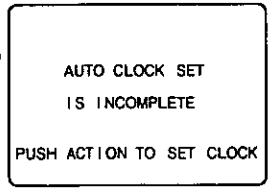
a  **Display SET CLOCK screen.**
Press ACTION to exit this mode.

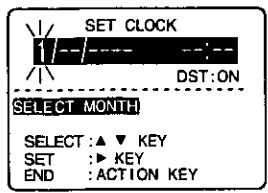
b  **Set the clock manually.**
1) Press ▲▼ to select the month.
2) Press ▶ to set.
• Likewise set date, year, time, and DST (Daylight Saving Time.)
To Make Corrections, repeatedly press ◀▶ to move to error, then correct.

c  **End setup.**
Press ACTION twice (Clock starts.)

Notes

- This unit's calendar is accurately maintained up to Dec. 31, 2089, 11:59 PM.
- Channel auto set selects normal TV or Cable channels depending on your unit hookup.

ACTION key on the unit

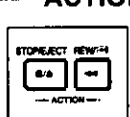

On Unit

You can operate the menu screen using unit buttons. To display the menu, press STOP/EJECT and REW together with no tape inserted. To exit the menu, repeat above with or without tape inserted.

Using ▲▼◀▶ keys

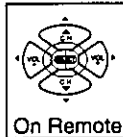

On Remote

- ▲ : CH UP
- ▼ : CH DOWN
- ▶ : VOLUME UP
- ◀ : VOLUME DOWN

Whenever the menu or program screen is displayed, CHANNEL UP/DOWN function as ▲▼ and VOLUME UP/DOWN function as ◀▶ only.

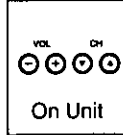

On Unit

TV Operation

Important: if the remote control POWER, CH Up/Down, NUMBERED keys, ACTION, PROG/CR+, DISPLAY, SEARCH, R-TUNE, FM/TV, or ADD/DEL button does not work when pressed, press COMBO button on the remote and try the button again.

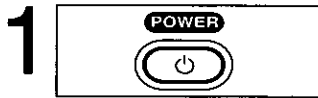

1 Press **POWER*** on the remote or unit.

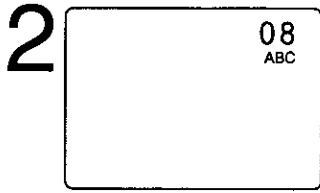

2 Select a channel. Using CH ▲▼ or NUMBERED keys.

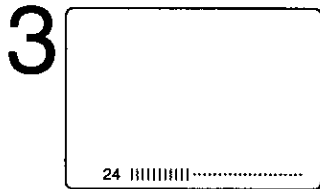
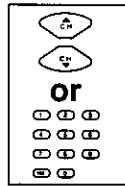

3 Adjust volume. Press VOL + -.

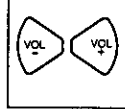

- Check list before you begin.
- All connections are made. (See page 7.)
 - Your unit is plugged in.

Model PV-C2540 unit is shown here.

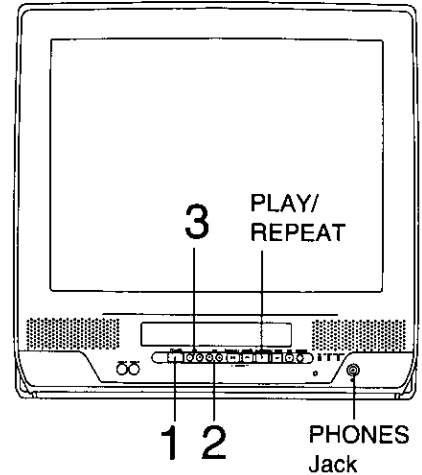

NIGHT (NITE) Mode

Color and picture intensity levels are adjusted so the screen is easier on your eyes during night time use.

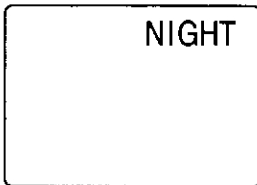

Set NIGHT mode.



Press NITE.
 • NIGHT mode may be selected when watching TV, playing a tape, or while in FM mode.

- To Cancel**, press NITE.
- Previous settings are restored.
 - NIGHT mode is canceled when power is turned off or power failure occurs.

■ Using the 100 key

When selecting CABLE channels 100 to 125 with the NUMBERED keys, first press the 100 key, and then enter the remaining two digits.

■ Rapid Tune

Press R-TUNE to display the last channel you were watching.

■ Audio Mute

Press MUTE to instantly mute the sound.
 Press again, to restore the previous sound level.

■ Phones

Connect an earphone (not supplied) or headphones (not supplied) to the Phones Jack.

■ SELF-DEMO Mode

With Power ON, hold down PLAY/REPEAT on the unit for 5 seconds to display demo screen.
 Repeat this to exit.

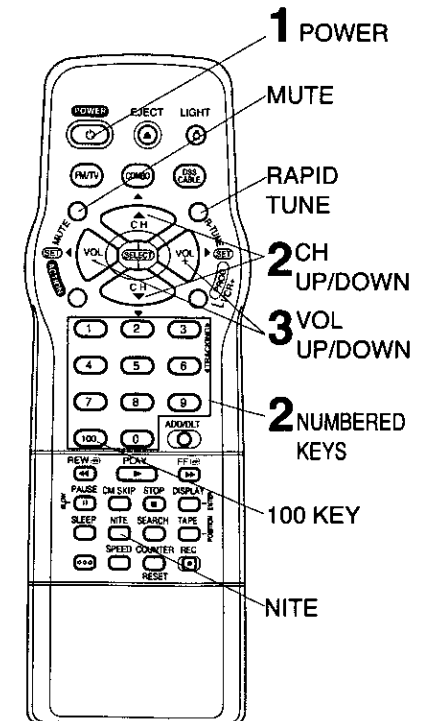

Model PV-C2540 remote is shown here.

MTS Broadcast/TV Stereo System

Receivable Broadcast Types

The following are possible broadcast types with their accompanying on-screen displays. The signal being received is indicated with an "Ⓢ" mark while the selected audio mode is indicated with an arrow.

To change the audio mode for these broadcasts, follow the "Select Audio Mode for TV Viewing" section (below.)

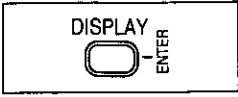

Display the broadcast signal being received.

Press DISPLAY to display.

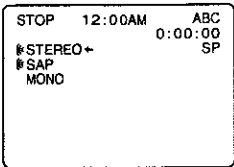

MTS Stereo and SAP broadcast

Multi-channel Television Sound Stereo (main language) and Secondary Audio Program (sub language) broadcasts are both being received simultaneously. Select the STEREO or SAP audio mode.

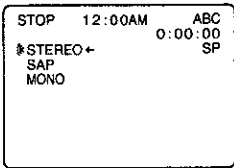

MTS Stereo broadcast

Multi-channel Television Sound Stereo broadcast. Select STEREO audio mode.

- If stereo broadcast is weak and the display flickers, select MONO audio mode for possibly better results.

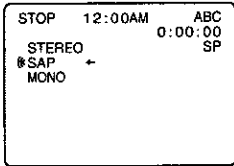

SAP broadcast

Secondary Audio Program (sub language). Select SAP audio mode for the sub language.

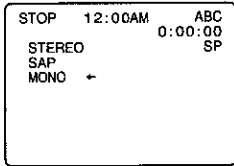

MONO broadcast

Normal monaural sound broadcast.

Select Audio Mode for TV Viewing



Press AUDIO to select the desired audio mode as described above.

(Arrow shows selection.)

- Each press of AUDIO will change the audio mode as shown below.
- "SAP" is selected with first press of AUDIO.

< Example >

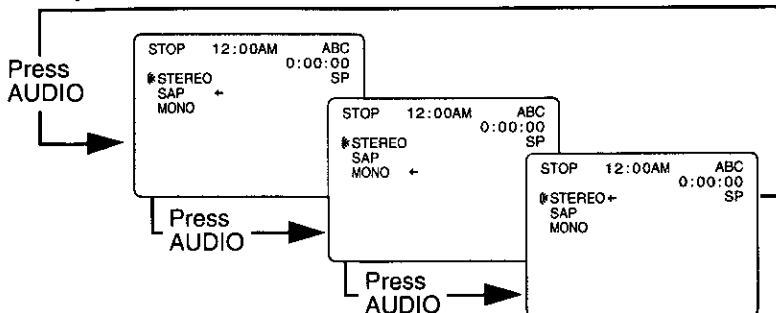

<For Model PV-C2580 only>

Equipped with dbx[®] -TV Noise Reduction for true MTS reproduction.

dbx[®] -TV Noise Reduction is required for good stereo separation and audio fidelity. dbx[®] is a registered trademark, and is licensed by dbx[®] Technology Licensing.

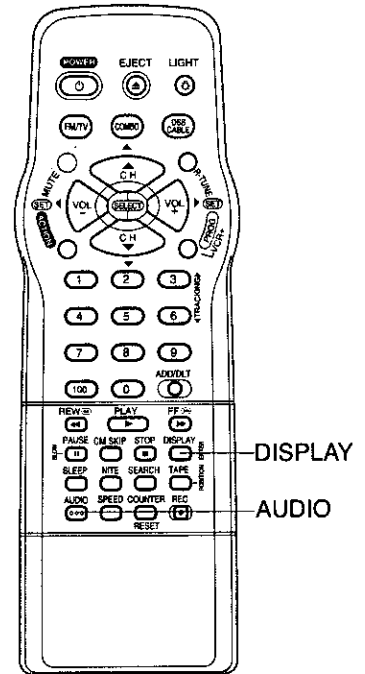

Model PV-C2580 remote is shown here.

Playback a Tape

Model PV-C2540 unit is shown here.

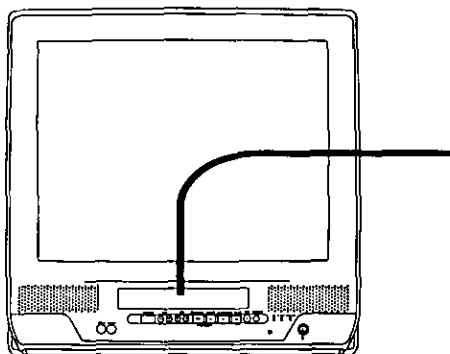

Check list before you begin.

- All connections are made. (See page 7.)
- Your unit is plugged in.

1

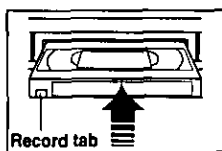

Insert a cassette.

- The unit power comes on automatically.

Note

To prevent tape jam
Inspect your cassette tapes and remove any loose or peeling labels.

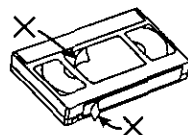

2



Press PLAY.

- Playback begins if cassette has no record tab.

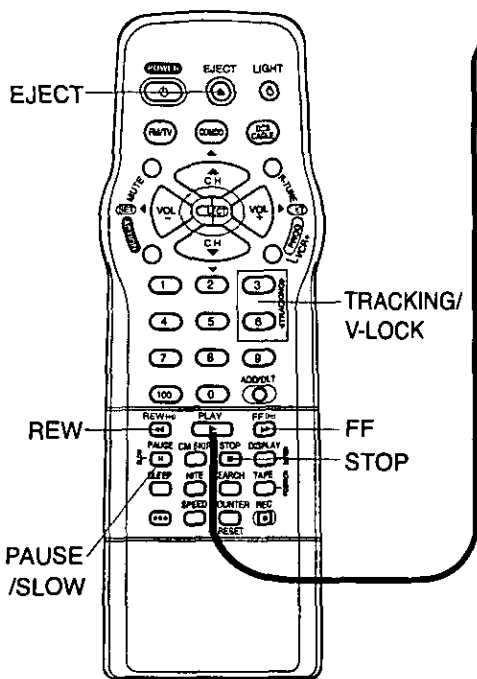

Model PV-C2540 remote is shown here.

To Find a Particular Scene

- Forward Search → Press FF
(To release, press PLAY or FF)
- Reverse Search → Press REW
(To release, press PLAY or REW)

To view a Still (Freeze) picture →

- Press PAUSE/SLOW (To release, press PLAY)

To view in Slow Motion →

- Press and hold PAUSE/SLOW in the Still mode
(To release, press PLAY)

To view Frame by Frame Advance →

- Press PAUSE/SLOW in the Still mode (To release, press PLAY)

Note

After the unit is in Still or Slow mode for 3 minutes, it will switch to Stop mode automatically to protect the tape and the video head.

- **To stop** → Press STOP
- **To rewind tape** → Press REW in Stop mode
- **To fast forward tape** → Press FF in Stop mode
- **To eject tape** → Press EJECT on the remote or STOP/EJECT on the unit

You can operate on the unit
<Model PV-C2540 unit is shown here.>

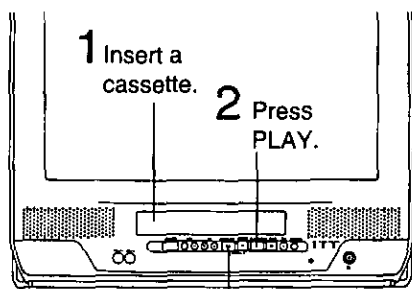

- Press to stop and/or eject tape.

Features for a Quality Picture

Digital Auto Tracking

Continuously analyzes the signal and adjusts for optimum picture quality.

Manual Tracking Control (to reduce picture noise)

Use during Playback and Slow Motion mode to reduce picture noise. Press the 3 or 6 NUMBERED key on the remote control or CH ▲▼* on the unit until the picture clears up. To return to Auto Tracking, press POWER off, then on again a few seconds later.

V-Lock Control

In Still mode, the 3 or 6 NUMBERED key on the remote control or CH ▲▼ on the unit operate as a V-Lock control to reduce jitter.

PanaBlack™ Picture Tube

This unit uses a PanaBlack™ picture tube for better color reproduction and picture contrast.

Record On a Tape

Important: if the remote control POWER, CH Up/Down, NUMBERED keys, ACTION, PROG/CR+, DISPLAY, SEARCH, R-TUNE, FM/TV, or ADD/DLT button does not work when pressed, press COMBO button on the remote and try the button again.

Model PV-C2540 unit is shown here.

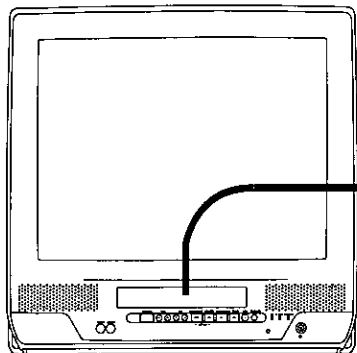

Check list before you begin.

- All connections are made. (See page 7.)
- Your unit is plugged in.
- Cassette with record tab in place.

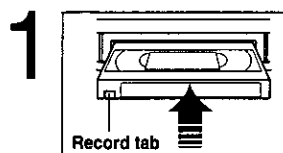

Insert a cassette.

- The unit power comes on automatically.

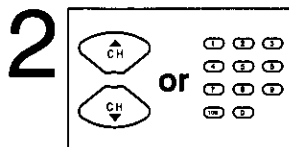

Select Channel.

Press CH ▲▼, or NUMBERED keys.

- To select "LINE," see bottom of this page.

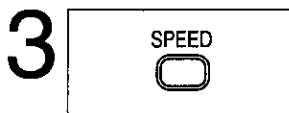

Select Recording speed (see page 6.)

Press SPEED.

SP = Standard Play
LP = Long Play
SLP = Super Long Play

- Selected speed is displayed.



Start Recording.

Press REC.

- To edit out unwanted portions, press PAUSE/SLOW to pause and resume recording.
- You cannot view another channel during recording.

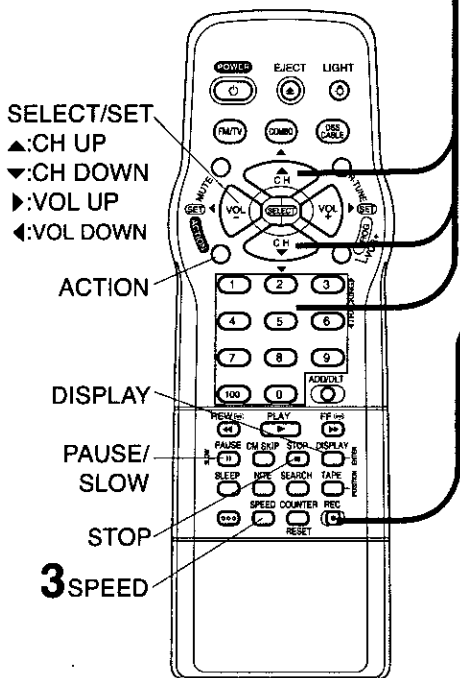

Model PV-C2540 remote is shown here.

■ To stop → Press STOP

■ One Touch Recording (OTR)

Press REC repeatedly to set the recording length (30 min - 4 hours.)

- The unit stops recording at a preset time.
- PROG TIMER indicator lights on the unit.

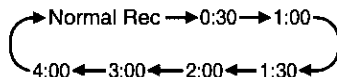

Notes

- After the unit has been in Rec Pause mode for 5 minutes, it will stop automatically to protect the tape and video head.
- The remaining recording time of an OTR can be displayed by pressing DISPLAY.

Selecting Input Mode

Method 1:

Press CH ▲▼. The display will change as follows.

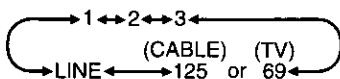

Method 2:

- a Press ACTION for MAIN MENU.
- b Press ▲▼◀▶ to select "TV", then press ACTION for SET UP TV screen.
- c Press ▲▼ to select "INPUT SELECT," and then press ▶ to select "TUNER" or "LINE."
- d Press ACTION twice to exit this mode.

You can operate on the unit
<Model PV-C2540 unit is shown here.>

1 Insert a cassette. **2** **4**

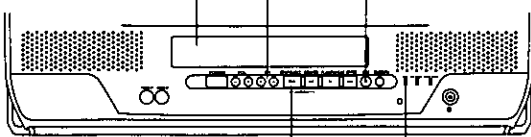

■ Press to stop. REC Indicator

Timer Recording

You can set up to 8 programs to be recorded while you are away.

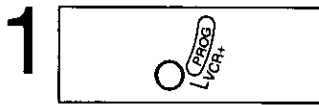

Display SET PROGRAM.

Press PROG/VCR+*.

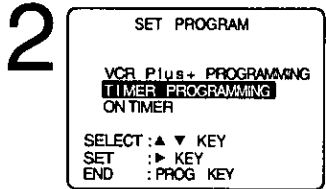

Select TIMER PROGRAM.

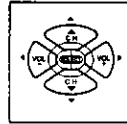

- 1) Press ▲▼ to select.
- 2) Press ► to display.

• If a program is already in memory, press ▲▼, and ► to select an unused program number.

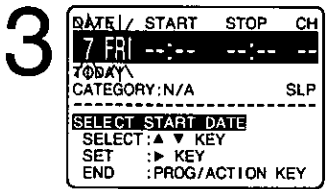

Set the recording DATE.

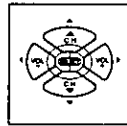

- 1) Press ▲▼ to select.
- 2) Press ► or ◀ to set.

- 1-31 = One time
- DAILY = MON-FRI
- WEEKLY SUN-SAT = Same time once a week

Example

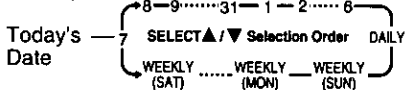

Repeat step 3 to set:

- start time, stop time
- Channel (or LINE for outside source)
- Category [N/A (not applicable), SPORTS, MOVIE, COMEDY, MUSIC, DRAMA]
- Speed (SP, LP, SLP)

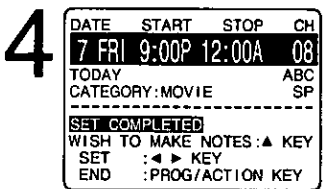

Make the notes.

(If not wanted, go to step 5.)

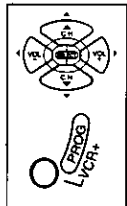

- 1) Press ▲ to begin.
- 2) Press ▲▼ to select.
- 3) Press ► or ◀ to set.
- 4) Press PROG/VCR+ (or ACTION) to end.

• Characters will change in the following order.

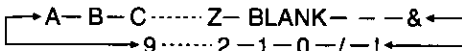

Continued on the next page.

Notes

- 2 minutes before Timer recording is performed, "PLEASE PREPARE FOR TIMER REC" appears and/or the PROG TIMER indicator flashes. Be sure a cassette with record tab is loaded and the unit is in Stop mode.
- If the start times of two programs overlap, the lower numbered program will have priority.
- If the start time for a Timer Recording comes up during a normal recording or One Touch Recording (page 13), the Timer Recording will not be performed.
- If there is a power interruption of more than one minute, the recording may not be performed or continue.
- If "INCOMPLETE" appears after all items have been set, check all entries and make necessary corrections.

✓ Check list before you begin.

- All connections are made. (See page 7.)
- Your unit is plugged in.
- The clock is set to correct time.
- The tape is long enough.
- The record tab is in place.

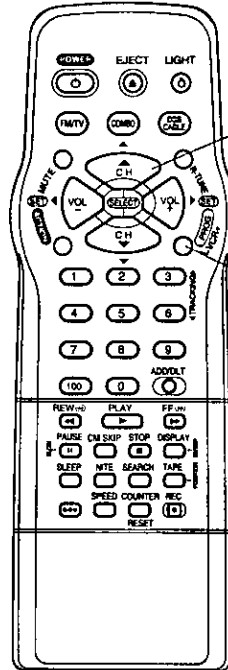

Model PV-C2540 remote is shown here.

Timer Recording Using unit Buttons

You can set a Timer Recording using ACTION key on the unit. (See page 9.)

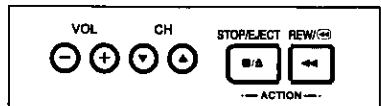

- 1 Press STOP/EJECT and REW together without a tape inserted to display MAIN MENU.
- 2 Press ▲▼ + - to select "VCR" and STOP/EJECT and REW together to display SET UP VCR screen.
- 3 Press ▲▼ to select "TIMER PROGRAM" and + to display the TIMER PROGRAM screen.
- 4 Repeat main steps 3-6.

• Important: if the remote control POWER, CH Up/Down, ACTION, PROG/VCR+, DISPLAY, SEARCH, R-TUNE, FM/TV, or ADD/HLT button does not work when pressed, press COMBO button on the remote and try the button again.

5

P	DT	START	STOP	CH	SPD
1	day	9:00p	12:00a	08	SP
2	---	---	---	---	---
3	---	---	---	---	---
4	---	---	---	---	---

CANCEL: ADD/HLT KEY
 SELECT 1-8: ▲ ▼ KEY
 ENTER: ► KEY
 END: PROG/ACTION KEY

End the program.

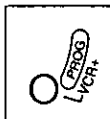

Press PROG/VCR+ (or ACTION.)

To Enter More Programs
 Press ▲▼ and ► to select and set a blank program number, and then repeat steps 3 and 4.

Cancel a Timer Recording: (Recording is in progress)

Hold down STOP for a few seconds to cancel the Timer Recording.

- Any future daily or weekly recordings will be performed as programmed.

6

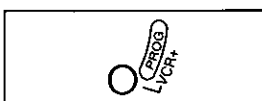

Exit this mode.

Press PROG/VCR+ (or ACTION) twice.

- If you're using a cable box, make sure that it is turned to the desired channel and the power is left on for timer recording.
- PROG TIMER indicator lights on the unit.

Model PV-C2540 unit is shown here.

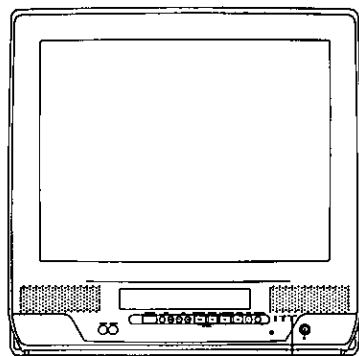

PROG TIMER indicator

Review, Replace or Clear Program Contents : (Recording is not in progress)

a Repeat steps 1 and 2 on page 14.

b

P	DT	START	STOP	CH	SPD
1	day	9:00p	12:00a	08	SP
2	8	10:00a	12:00p	125	SP
3	10	8:00p	9:00p	10	SP
4	SU	9:00p	10:00p	L	LP

CANCEL: ADD/HLT KEY
 SELECT 1-8: ▲ ▼ KEY
 ENTER: ► KEY
 END: PROG/ACTION KEY

Select the desired program.

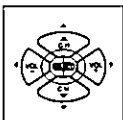

Press ▲▼ to select.

c To Replace program...

DATE	START	STOP	CH
8 SAT	9:00P	12:00A	08
7 DAY			ABC
			SP

CATEGORY: MOVIE
 NOTES: STAND BY ME
 SELECT START DATE
 SELECT: ▲ ▼ KEY
 SET: ◀ ▶ KEY
 END: PROG/ACTION KEY

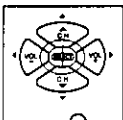

- 1) Press ► to display.
- 2) Press ▲▼ to select and ◀ or ► to set new program contents.
- 3) Press PROG/VCR+ (or ACTION.)

To Clear program...

P	DT	START	STOP	CH	SPD
1	---	---	---	---	---
2	8	10:00p	12:00a	125	SP
3	10	8:00p	9:00p	10	SP
4	SU	9:00p	10:00p	L	LP

SELECT 1-8: ▲ ▼ KEY
 ENTER: ► KEY
 END: PROG/ACTION KEY

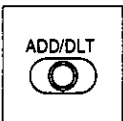

Press ADD/HLT.

d



Exit this mode.
 Press PROG/VCR+ (or ACTION) twice.

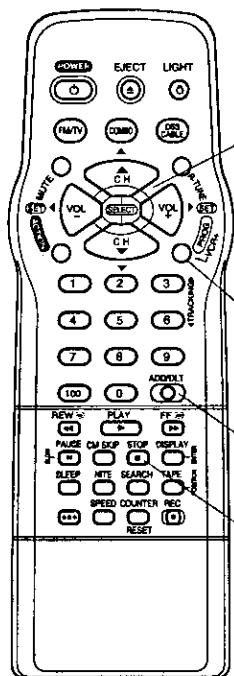

- b** SELECT/SET
- c** ▲: CH UP
▼: CH DOWN
►: VOL UP
◀: VOL DOWN
- C** PROG/VCR+
- d** ADD/HLT
- STOP

Model PV-C2540 remote is shown here.

Advanced Operation

Timer Programming using VCR Plus+® System

VCR Plus+ System is...

a feature that allows you to set most items of a Timer Recording by simply entering a special code number (PlusCode) found in TV GUIDE and selected newspaper TV listings.

Process of Recording

Connection ⇨ **Setup** ⇨ **Programming**

Choose your connection type from the following diagrams

■ CABLE BOX → UNIT

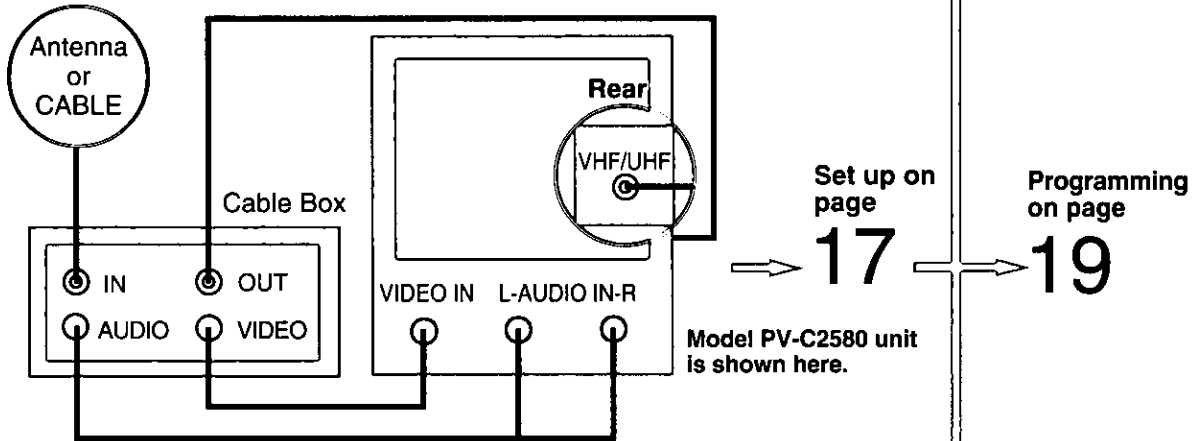
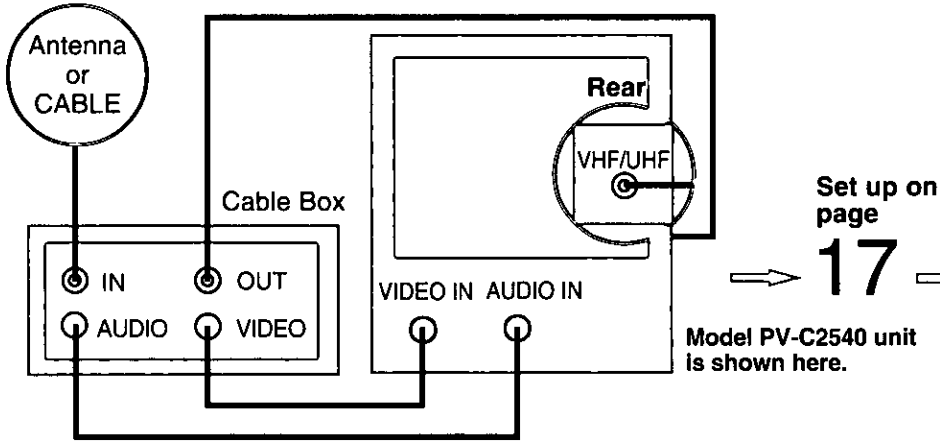

■ ANTENNA or CABLE → UNIT

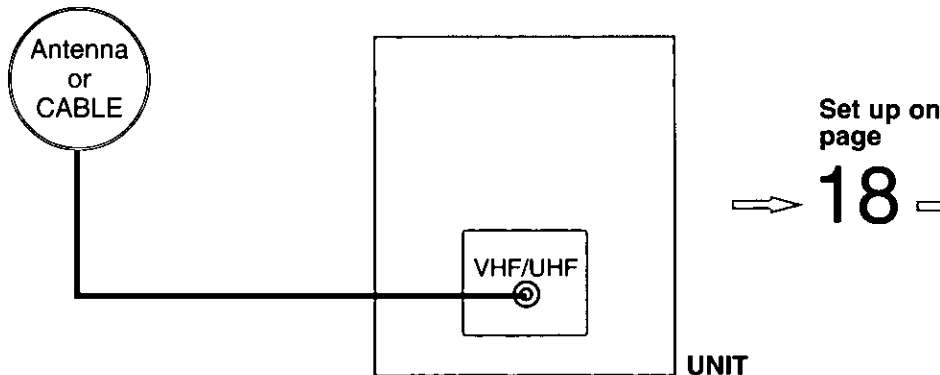

Important: if the remote control POWER, CH Up/Down, NUMBERED keys, ACTION, PROG/VCR+, DISPLAY, SEARCH, R-TUNE, FM/TV, or ADD/HLT button does not work when pressed, press COMBO button on the remote and try the button again.

Cable Box Setup

Process of Recording



Display MAIN MENU.

Press ACTION*.

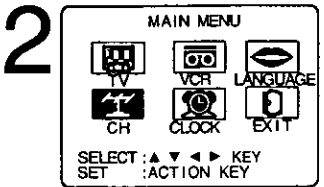

Display SET UP CH screen.

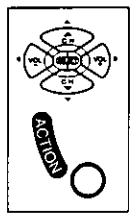

- 1) Press ▲▼◀▶ to select "CH."
- 2) Press ACTION to display.

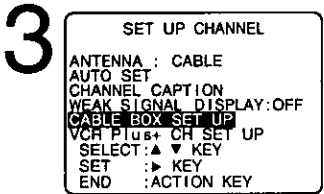

Select CABLE BOX SET UP.

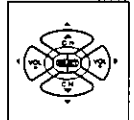

- 1) Press ▲▼ to select.
- 2) Press ► to display.

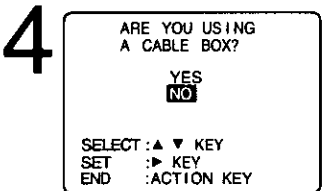

Select "YES" or "NO."

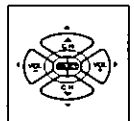

- 1) Press ▲▼ to select "YES" or "NO."
- 2) Press ► to set.

If you select...

- "YES" → Step 5.
- "NO" → Press ACTION → Go to VCR Plus+ Channel Setup on page 18.

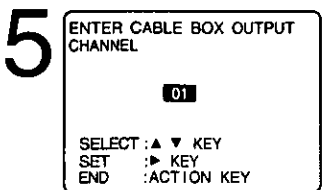

Select Cable Box output channel number.

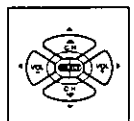

- 1) Press ▲▼ to select.
- 2) Press ► to enter.

- If necessary, refer to your cable box manual.
- If you are using Audio/Video jack connection for your cable box, select and set "VIDEO OUT" as the output channel.

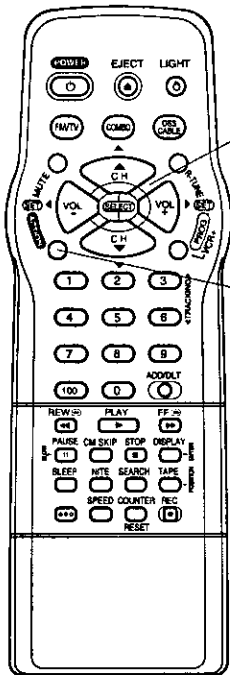

- 2: SELECT/SET
- 3: ▲:CH UP
- 4: ▼:CH DOWN
- 5: ►:VOL UP
- 5: ◀:VOL DOWN
- 1: ACTION
- 2: [CABLE BOX]

Model PV-C2540 remote is shown here.

Advanced Operation

VCR Plus+ and PlusCode are registered trademarks of Gemstar Development Corporation. The VCR Plus+ system is manufactured under license from Gemstar Development Corporation.

VCR Plus+ Channel Setup is... necessary to program the unit with local channel information for proper VCR Plus+ operation.

Process of Recording



VCR Plus+ Channel Setup

At first, do Channel Setup Preparations below right.

1  **Display MAIN MENU.**
Press ACTION*.

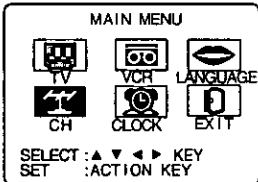
2  **Display SET UP CH screen.**
1) Press ▲▼◀▶ to select "CH."
2) Press ACTION to display.

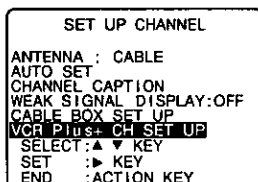
3  **Select VCR Plus+ CH SET UP.**
1) Press ▲▼ to select.
2) Press ▶ to display.

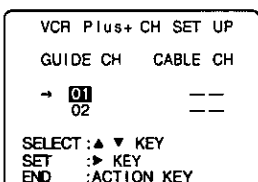
4  **Enter VCR Plus+ channels.**
1) Press ▶ to move cursor to right column.
2) Press ▲▼ to change the CABLE CH number.
3) Press ◀ to set.
4) Press ▲▼ to scroll up/down the GUIDE CH column.
• Repeat step 4 until list is complete.

To Make Corrections

Press ▲▼ and ▶ to move to error, then ▲▼ to change, or ADD/DLT to erase number.

5  **End the setup.**
Press ACTION three times.

Notes

- Make each entry within 5 minutes or the unit will leave this mode.
- Once local channels have been programmed, they will stay in memory, even in the case of a power failure.

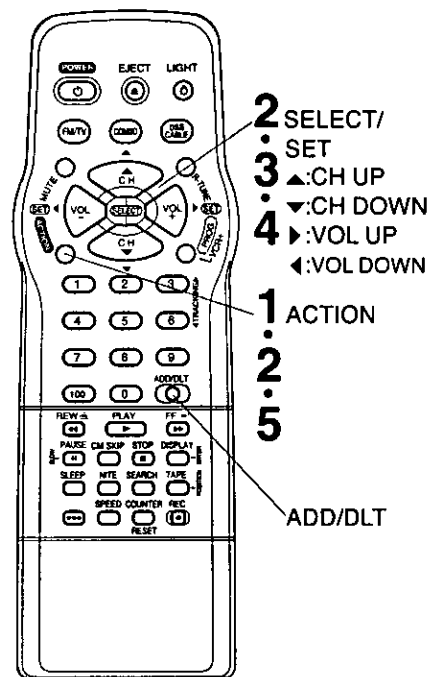

Model PV-C2540 remote is shown here.

Channel Setup Preparations

To complete step 4 left, make a local channel list (see example below.)

You will need the following:

- A normal TV and/or Cable stations line up and the channel numbers you receive them on.
- A list of Guide (VCR Plus+) channel numbers for stations you receive (see TV Guide and selected newspapers.)

- 1 Make a 3-column chart. In the left column, write all station names you receive.
- 2 In the middle column, write each station's Guide (VCR Plus+) number.
- 3 In the right column, write the channel number your TV receives the station on.

< EXAMPLE ONLY >

Broadcast or Cable Station Name	Assigned Guide (VCR Plus+) Channel no.	Channel no. your TV receives the station on
HBO	33	15
Nickelodeon	38	20
CBS	34	04
FOX	11	

Important: if the remote control POWER, CH Up/Down, ACTION, VCR/VCR+, DISPLAY, SEARCH, R-TUNE, FM/TV, or ADD/HLT button does not work when pressed, press COMBO button on the remote and try the button again.

VCR Plus+ System Programming

Process of Recording

Connection → Setup → Programming

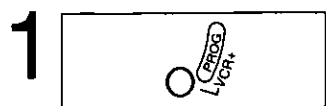

1 Display PROGRAM screen.
Press PROG/VCR+.

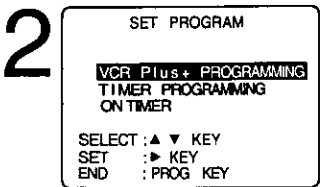

2 Select VCR Plus+ PROGRAM.

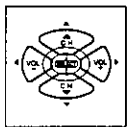

1) Press ▲▼ to select.
2) Press ► to display.

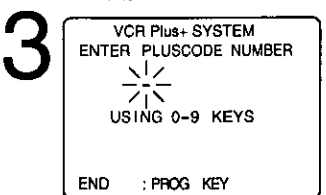

3 Enter PlusCode programming number.

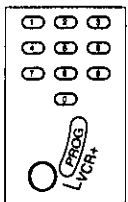

1) Press NUMBERED keys.
2) Press PROG/VCR+ when finished.

To Make Corrections

Press ◀ repeatedly to delete the PlusCode programming number.

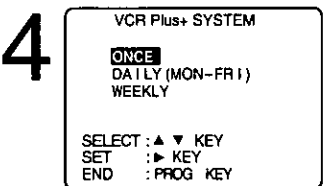

4 Set Record Frequency.

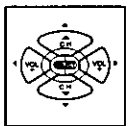

1) Press ▲▼ to select.
2) Press ► to set.

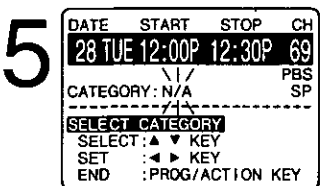

5 Set Category and Record speed.

• If wanted, make a note (see page 14.)

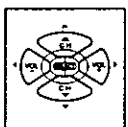

1) Press ▲▼ to select.
2) Press ► to set.

Select desired type:

- Categories → N/A (not applicable), SPORTS, MOVIE, COMEDY, MUSIC, or DRAMA
- Speed → SP, LP, or SLP

To Make Corrections

Press ◀▶ to move the cursor and ▲▼ to make the correction.

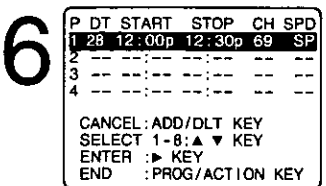

6 End programming.

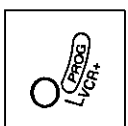

Press PROG/VCR+ (or ACTION.)

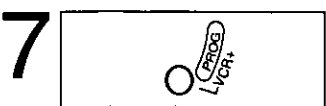

7 Exit this mode.

Press PROG/VCR+ (or ACTION) twice.

- PROG TIMER indicator lights on the unit.

Check list before you begin.

- The clock is set to correct time.
- VCR Plus+ System Setup is complete. (See pages 17, 18.)

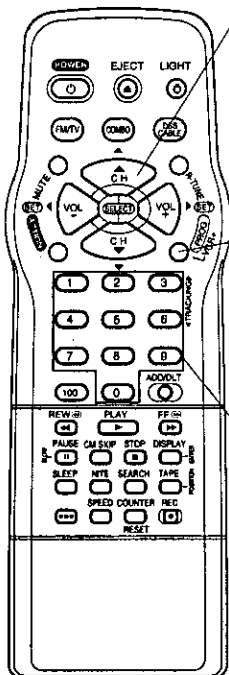

2 SELECT/SET
4 ▲:CH UP
5 ▼:CH DOWN
6 ►:VOL UP
7 ◄:VOL DOWN
1 3 : PROG/VCR+
6 :
7 :
3 NUMBERED Keys

Model PV-C2540 remote is shown here.

Use normal Timer Recording steps if:

- a program PlusCode programming number is not listed.
- program, such as a sporting event, may run over scheduled stop time.

See page 15 to:

- cancel a timer recording in progress.
- replace program contents.
- review or clear program contents once set.

Notes

- You can obtain unlisted PlusCode programming numbers by calling 1-900-454-7587. Call costs approximately \$.95 per minute.
- Avoid overlapping program times.
- If you're using a cable box, make sure that it is turned to the desired channel and the power is left on for timer recording.
- Timer programs memory capacity is 8. To add more programs, please first clear other programs. (See page 15.)

TV Timer Features

ON-TIMER with Alarm

This unit can be set to automatically power on in one of 3 modes (TV, Playback, or FM radio.) You can also combine the On-Timer with a one minute alarm that gradually increases in volume.

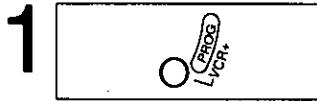

Display PROGRAM screen.

Press PROG/VCR+*.

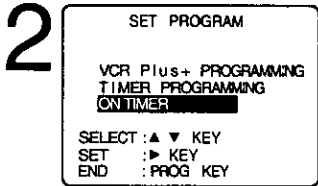

Select ON-TIMER.

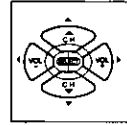

- 1) Press ▲▼ to select.
- 2) Press ► to display.

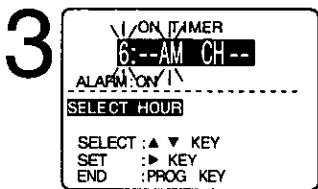

Set the ON-TIMER TIME.

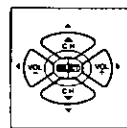

- 1) Press ▲▼ to select.
- 2) Press ► to set.

- ON-TIMER mode selection order

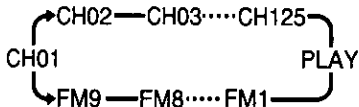

- Make sure a tape is inserted if Playback mode is selected.
- See "FM Radio" on pages 34 and 35 for instructions on how to preset FM stations.

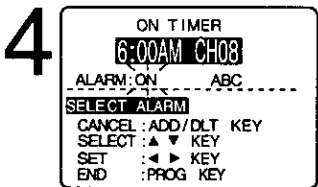

Set Alarm.

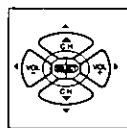

Press ▲▼ to select "ON" or "OFF."

When "ON" is selected, an alarm will gradually increase in volume for one minute or until canceled by pressing any button (including VOL + -.)

To Make Corrections, use ▲▼ and ◀▶ to move back and correct as necessary.

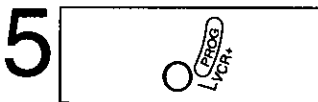

Set ON TIMER.

Press PROG/VCR+.

- "ON TIMER SET" is displayed.
- ON TIMER indicator lights on the unit.

To cancel ON-TIMER set, Repeat steps 1 and 2. Then, press ADD/HLT to clear the time in step 3. Now, press PROG/VCR+ to end. "ON TIMER END" appears on-screen for a few seconds.

Check list before you begin.

- The clock is set to correct time.

Model PV-C2540 unit is shown here.

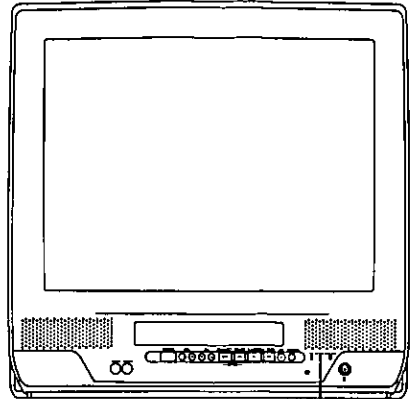

ON TIMER indicator

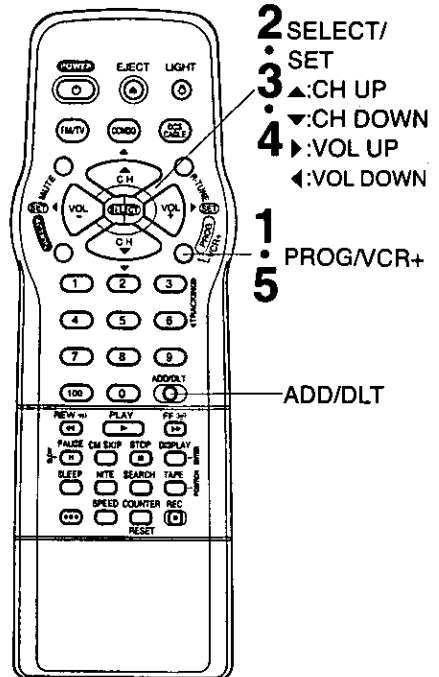

Model PV-C2540 remote is shown here.

Note

If no button on the remote or unit (including a button used to turn off the alarm) is pressed within 60 minutes after unit turns itself on, it will turn itself back off.

* Important: if the remote control POWER, CH Up/Down, NUMBERED buttons, ACTION, PROG/VCR+, DISPLAY, SEARCH, R-TUNE, FM/TV, or ADD/HLT button does not work when pressed, press COMBO button on the remote and try the button again.

SLEEP TIMER

This unit can be set for auto power off.



Set SLEEP TIMER.

Press SLEEP repeatedly.

- Pressing DISPLAY with sleep timer set displays remaining time.

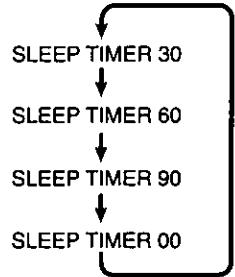

To Cancel, press SLEEP repeatedly until "SLEEP TIMER 00" appears.

Model PV-C2540 unit is shown here.

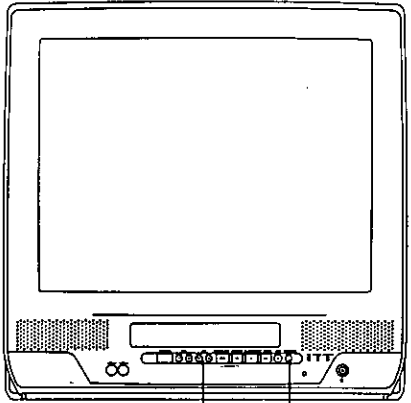

2 CH ▲▼ 1 TIMER/FM

INSTANT ALARM

The feature allows you to set a timer alarm for up to 60 minutes. Useful for when you are cooking and need to leave the kitchen.

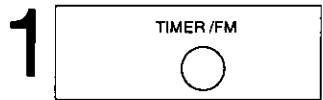

Display INSTANT ALARM screen.

Press TIMER/FM on the unit to display.

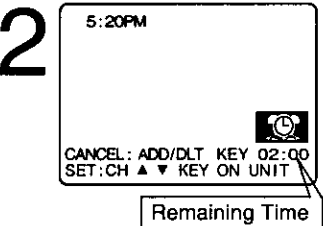

Set Alarm.

Press CH ▲▼ on the unit to select time while "CANCEL" and "SET" are displayed (see below.)

Press TIMER/FM on the unit repeatedly to change display as follows.

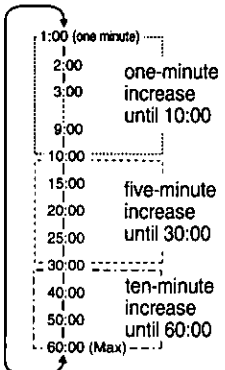

To cancel, press ADD/HLT while "CANCEL" and "SET" are displayed.

To increase timer in progress, Press CH ▲▼ on the unit to restart countdown rounded up to next 1, 5, or 10 minute interval while "CANCEL" and "SET" are displayed.

- <Example>
- If current time remaining is 12:15, countdown will restart from 15:00.
 - If current time remaining is 9:15, countdown will restart from 10:00.

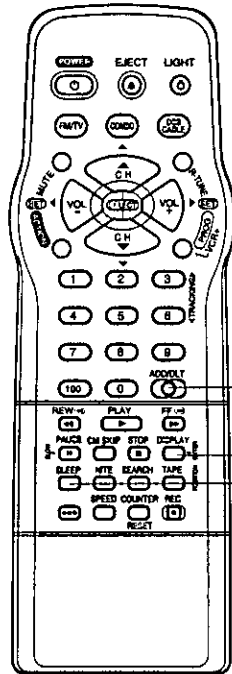

Model PV-C2540 remote is shown here.

3 Alarm will sound at 0: 00.

- Press any button to stop.
- The volume of the alarm gradually increases for one minute and then continues to beep until any button is pressed.

Note

While timer function is in progress, you can change channels on the unit with CH ▲▼ while "CANCEL" and "SET" are not displayed.

Advanced Operation

Closed Caption System

Closed Caption is ...

This multi-use system not only allows the hearing impaired to enjoy selected programs, but also makes useful information from TV stations available to everyone.

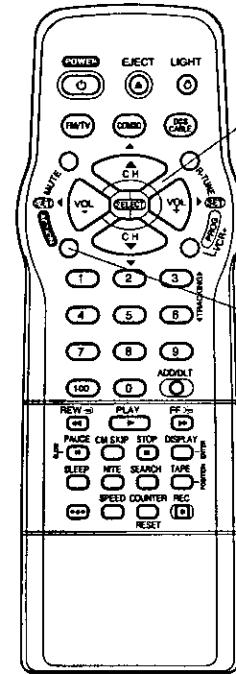

Model PV-C2540 remote is shown here.

Closed Caption Modes from which to Choose

Caption Mode: CAP C1 or C2

A narration of selected TV programs is displayed.

Check TV program listings for C. C. (Closed Caption) broadcasts.

Caption Mode: TEXT C1 or C2

The lower half of the screen will be blocked out. When the TV station broadcasts information, such as program listings, it will appear in this space.

Caption Mode: OFF

Closed Caption /Text narration will not be displayed.

NOTE:

The closed caption or text signal may be broadcast over C1, C2, or both. Also, text contents can vary so you may wish to try different settings.

For assistance, call 1-800-211-PANA(7262)

Closed Caption Mode Feature

1  **Display MAIN MENU.**
Press ACTION*.

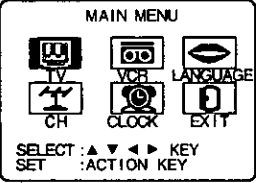
2  **Display SET UP TV screen.**
1) Press ▲▼◀▶ to select "TV."
2) Press ACTION to display.

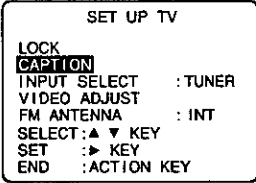
3  **Display CAPTION screen.**
1) Press ▲▼ to select.
2) Press ▶ to display.
<For Model PV-C2540 only>

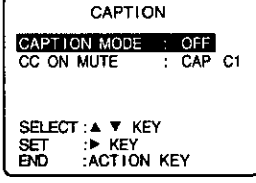
4  **Select CAPTION MODE.**
1) Press ▲▼ to select.
2) Press ▶ repeatedly to select caption mode.

5  **Return to the normal screen.**
Press ACTION three times.

Recording and Playing Back a Closed Caption/Text Program

Record:

Record normally. Closed Caption/Text signal, if present, is recorded automatically.

Playback:

Start playback. Do above steps to select desired caption mode.

Caption On Mute Feature

Closed Caption narration, if available, is displayed when MUTE button is pressed for silence.



Display MAIN MENU.

Press ACTION.

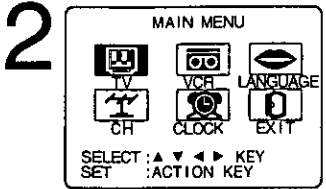

Display SET UP TV screen.

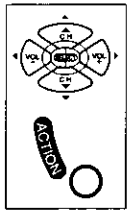

- 1) Press ▲▼◀▶ to select "TV."
- 2) Press ACTION to display.

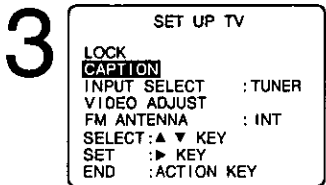

Display CAPTION screen.

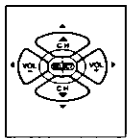

- 1) Press ▲▼ to select.
- 2) Press ▶ to display.

<For Model PV-C2540 only>

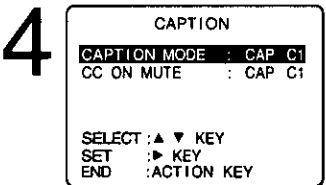

Set CAPTION MODE OFF.

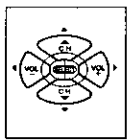

- 1) Press ▲▼ to select.
- 2) Press ▶ repeatedly to select "OFF."

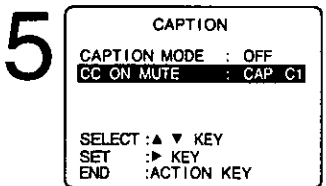

Select CC ON MUTE.

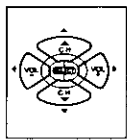

- 1) Press ▲▼ to select.
- 2) Press ▶ repeatedly to select desired caption mode.

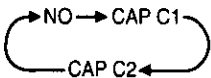

- Each press of ▶ will change the display as shown at left.
- The caption may be broadcast over CAP C1 or C2.

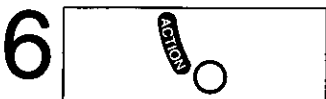

Return to the normal screen.

Press ACTION three times.

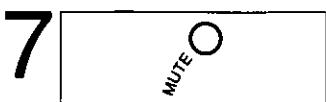

Mute sound, display closed captioning.

Press MUTE to mute the sound.

- To cancel, press MUTE again.

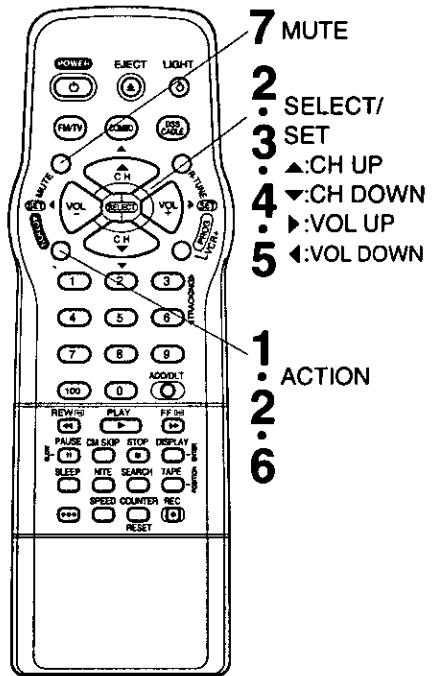

Model PV-C2540 remote is shown here.

Tape Operation

Commercial Skip

This unit fast forwards (skips) over 1-3 minutes of recorded tape during Play mode.

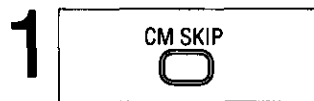

Set Skip Time.
Press CM Skip repeatedly to select skip time.

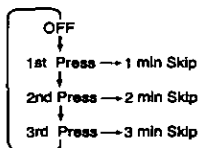

Program End Search

It is easy to detect the end of a recorded program so that you may continue or begin a new recording.



Display SELECT SEARCH MODE in Playback or Stop mode.
Press SEARCH* on the remote.

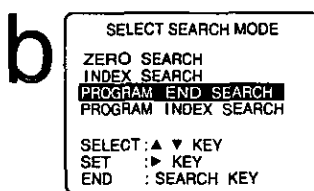

Display PROGRAM END SEARCH.
1) Press ▲▼ to select.
2) Press ► to start search.

Example of Program End Search operation.

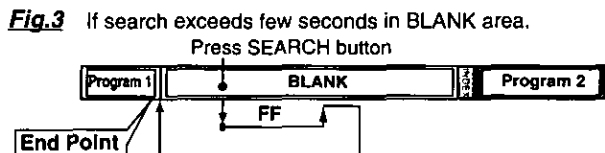
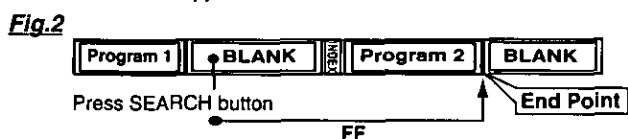
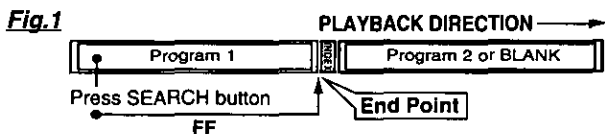

If Program End Point is found.
The search continues slightly beyond the end point, then search and reverse search and plays the last few seconds of the program and finally stop.

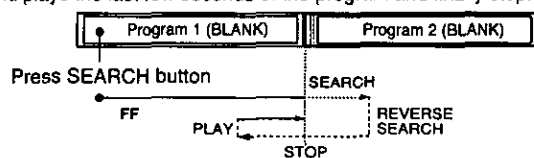

Notes

- If Program End Search is started very close to an index mark, one program may be skipped over.
- If you want to cancel Program End Search, Press PLAY or STOP.

Your unit is equipped with several time saving features as well as convenient automatic functions which make tape operation easier than ever.

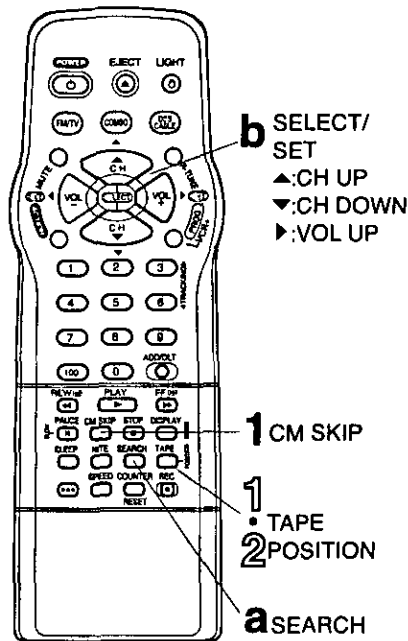

Model PV-C2540 remote is shown here.

Tape Position Display

To find out the present tape position. Tape position cannot be detected for C-Cassette and tapes of less than 60 minutes.

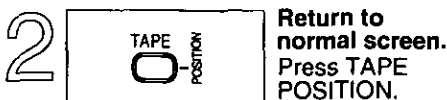
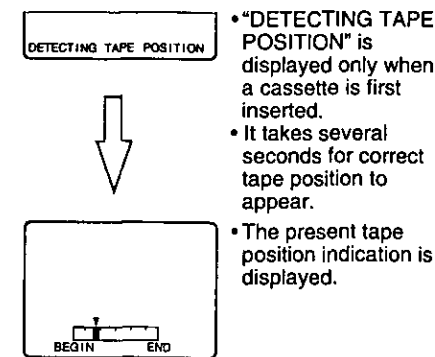
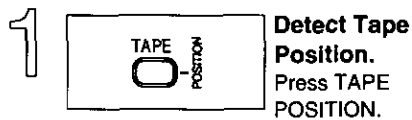

*Important: If the remote control POWER, CH Up/Down, ACTION, PROG/VCR+, DISPLAY, SEARCH, R-TUNE, FM/TV, or ADD/HLT button does not work when pressed, press COMBO button on the remote and try the button again.

Repeat Play

Set to see a recording over and over.



Display MAIN MENU.
Press ACTION.

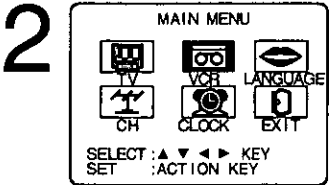

Display SET UP VCR screen.

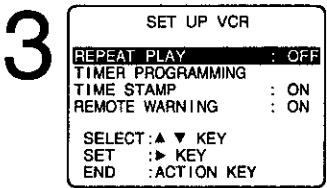
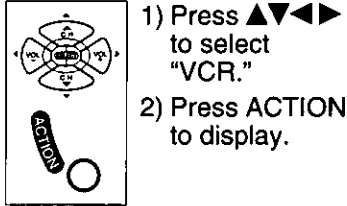

Select REPEAT PLAY.

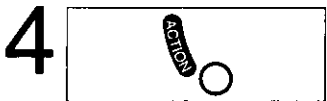
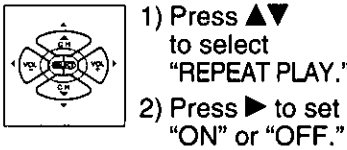

End setup.
Press ACTION twice.

Zero Search

To quickly return to a specific tape counter location.



Display the Counter.
Press DISPLAY during playback.

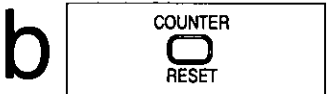

Reset to "0:00:00."
Press COUNTER RESET at the desired position.

c Continue playback, rewind, or fast forward.

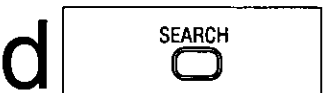

Display SELECT SEARCH MODE in Stop mode.
Press SEARCH.

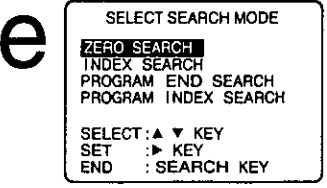

Select ZERO SEARCH.

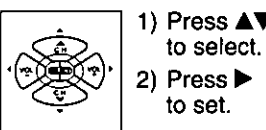

f **Return to "0:00:00."**
• Unit goes into FF or REW mode and stops at the last point the Counter was set to 0:00:00.

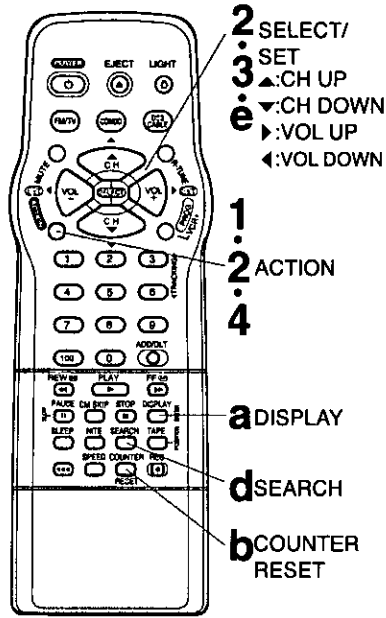

Model PV-C2540 remote is shown here.

Notes

- Playback repeats when tape end is reached or unrecorded portion over 30 seconds is detected.
- During playback, you may also press PLAY/REPEAT repeatedly on the unit to select REPEAT "ON" or "OFF."

Auto Operation Functions

- **Auto Shut Off**
No broadcast signal in TV, NIGHT or Playback mode for 5 minutes
→ Power turns off automatically
• This feature is deactivated if any button is pressed during the above mode.
- **Auto Playback**
Insert a tape in Power off mode
→ Power turns on automatically
• Playback begins automatically if a tape has no record tab.
- **Auto Rewind**
A tape reaches its end
→ Rewind begins
→ Stops automatically
- **Playback Auto Eject (Repeat Play is "OFF")**
A tape has no record tab reaches its end
→ Rewind begins
→ Ejects automatically
- **Memory Rewind off**
Press POWER in REW mode
→ Power turn off of TV (continued rewind)
→ Rewind is completed
→ All power turns off automatically

Advanced Operation

Tape Operation (continued)

Direct Access (For Normal and/or Timer recordings)

Go directly to the desired recording.

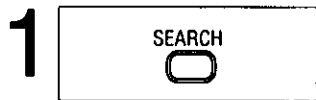

Display SELECT SEARCH MODE screen.
Press SEARCH* in Playback or Stop mode.

- If there are no Timer Recordings on the Program Index List, go to step 3.

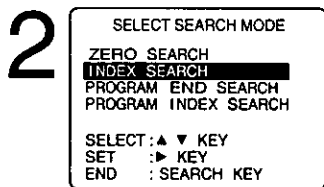

Display INDEX screen.

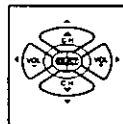

- 1) Press ▲▼ to select "INDEX SEARCH."
- 2) Press ► to display.

- This screen appears only if there are Timer Recordings.

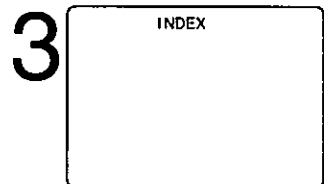

Select the recording number.

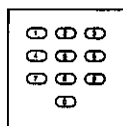

Press **NUMBERED** keys.

- To calculate number, see below.

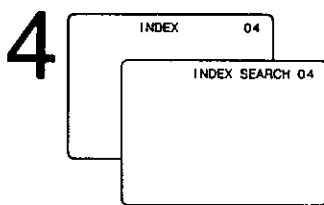

Start search.

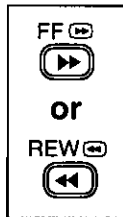

Press FF or REW.
• When search is finished, playback begins.

To calculate the Index Number

Example 1:

If you are watching recording 4 and you want to watch recording 2, enter 3 in step "3" and press REW.

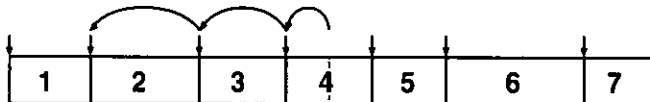

Example 2:

If you are watching recording 2 and you want to watch recording 6, enter 4 in step "3" and press FF.

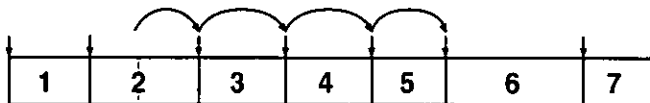

NOTE: ↓ indicates start points of each recording.

VHS Index Search System is ...

Each time recording is made, an invisible index mark is placed on the tape. When timer recordings are made, program index and information are also included. These index marks can be used to access or scan recordings.

Model PV-C2540 unit is shown here.

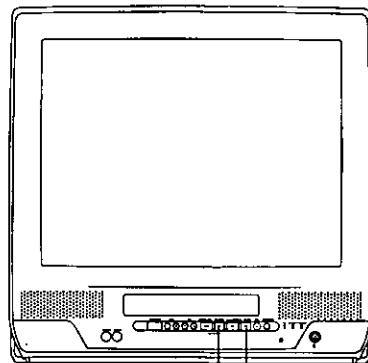

4 REW 4 FF

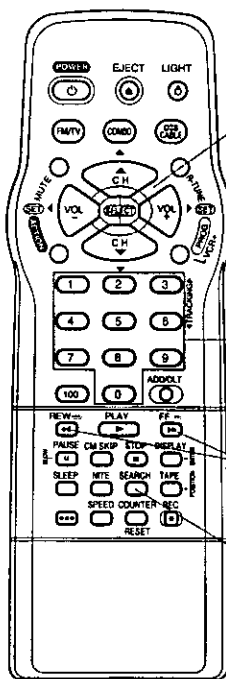

2 SELECT/SET

- ▲: CH UP
- ▼: CH DOWN
- : VOL UP

3 NUMBERED Keys

4 FF or REW

1 SEARCH

Model PV-C2540 remote is shown here.

Notes

- Make each entry within 10 seconds, or the Index Search mode will be canceled.
- If these VHS Index Search Systems are started very close to an index mark, that index mark may not be counted in the search.

• Important: if the remote POWER, CH Up/Down, ACTION, PROGRAM/CVR+, DISPLAY, SEARCH, R-TUNE, FM/TV, or ADD/DLT button does not work when pressed, press COMBO button on the remote and try the button again.

Program Index Search (For Timer recordings only)

Choose a timer recorded program from a Program Index List.



Display SELECT SEARCH MODE screen.
Press SEARCH in Playback or Stop mode.

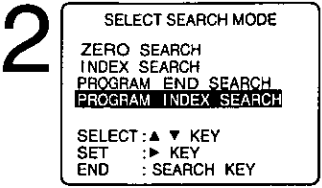

Display PROGRAM INDEX screen.

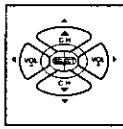

1) Press ▲▼ to select "PROGRAM INDEX SEARCH."
2) Press ► to display.



Select the desired recorded program.

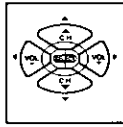

1) Press ▲▼ to select.
2) Press ► to start the forward or rewind search.

• When search is finished, playback begins.

Note

When the tape is ejected or normal recording is started, all program index data are deleted.

Index Scan (For Normal and/or Timer recordings)

In Play mode, the first 10 seconds of each recording can be scanned (forward or reverse.)

a 1) Repeat steps 1 and press ▲▼ to select "INDEX SEARCH."
2) Press ► to display INDEX screen.



Start the scan.

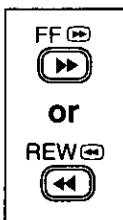

Press FF or REW.

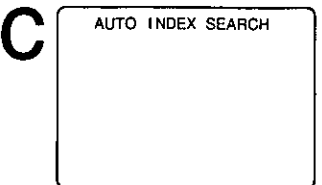

Cancel scan, start playback.

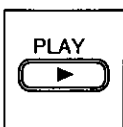

Press PLAY.
• To stop, press STOP.

Model PV-C2540 unit is shown here.

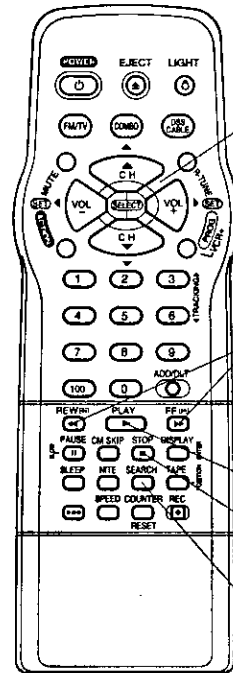
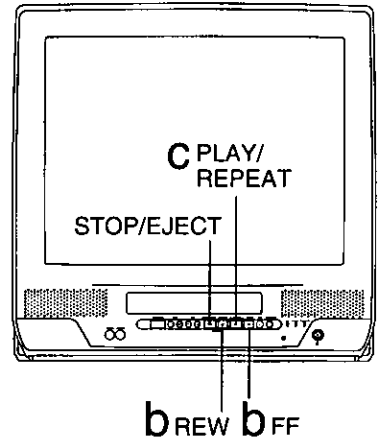

Model PV-C2540 remote is shown here.

<Example>

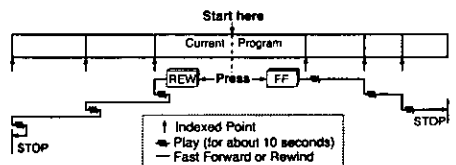

Special VCR Features

Preset Caption

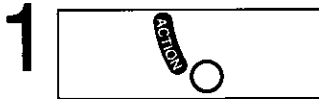

Display MAIN MENU.
Press ACTION*.

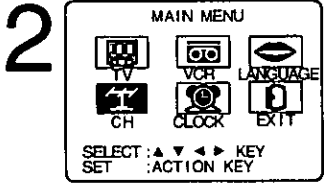

Display SET UP CH screen.

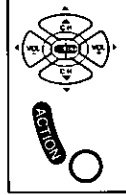

- 1) Press ▲▼◀▶ to select "CH."
- 2) Press ACTION to display.

Channel Caption Is ...
Station names, e.g. ABC, TNN, etc. so that they will appear when a channel is selected. Choose 24 preset names (Preset Caption), or make up to 10 names of your own (Manual Caption.)

Check list before you begin.

You need a list of stations and the channel numbers you receive them on.

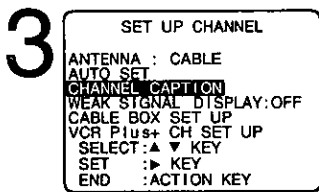

Select CHANNEL CAPTION.

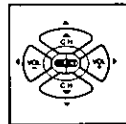

- 1) Press ▲▼ to select.
- 2) Press ▶ to display.

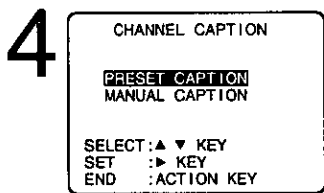

Select PRESET CAPTION.

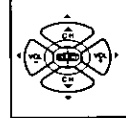

- 1) Press ▲▼ to select.
 - 2) Press ▶ to display.
- To create your own captions, go to "Manual Caption" on page 29.

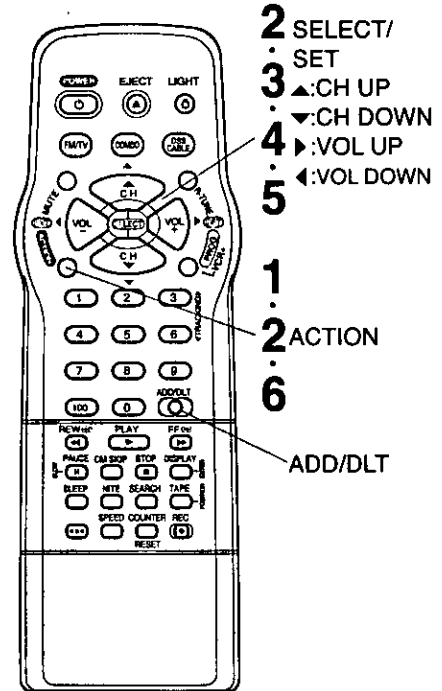

Model PV-C2540 remote is shown here.

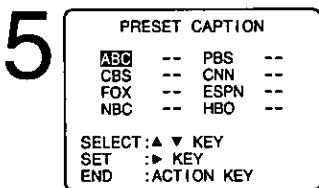

Go with preset captions.

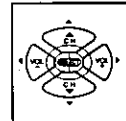

- 1) Press ▲▼ to select a station.
- 2) Press ▶ to move cursor to the right.
- 3) Press ▲▼ to select channel number.
- 4) Press ◀ to set.

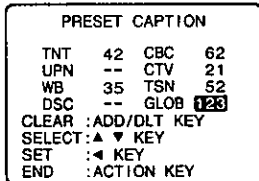

• Repeat step 5 until the Caption List is complete.

To Make Corrections

Press ▲▼, then ▶ to select channel number.
Press ▲▼ to change, or ADD/HLT to delete.



End setup.
Press ACTION four times.

*Important: if the remote control POWER, CH Up/Down, ACTION, PROG/VCR+, DISPLAY, SEARCH, R-TUNE, FM/TV, or ADD/DLT button does not work when pressed, press COMBO button on the remote and try the button again.

Manual Caption

1 Do "Preset Caption" steps 1~3 (page 28.)

2

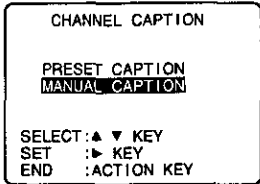

Select MANUAL CAPTION.

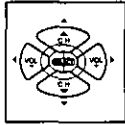

- 1) Press ▲▼ to select.
- 2) Press ► to display.

3

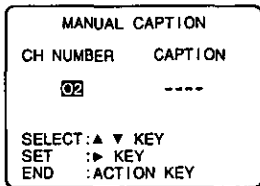

Select Channel number.

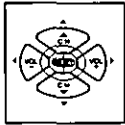

- 1) Press ▲▼ to select CH NUMBER.
- 2) Press ► to move cursor to the right.

- Channels already set and channels deleted from Channel Memory are not displayed.
- You can set a total of ten channel captions with up to four characters each.

4

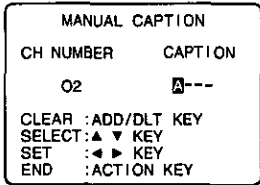

Enter your caption.

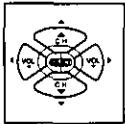

- 1) Press ▲▼ to select.
- 2) Press ► to enter.

- Characters change in the following order.

→ A—B—C.....Z—BLANK— — —&←
 → 9.....2—1—0—/—!←

- Press ◀ repeatedly to move the cursor to "CH NUMBER." Repeat steps 3 and 4 as desired.

To Make Corrections

Press ▲▼, then ► to select channel number.
 Press ▲▼ to change, or ADD/DLT to delete.

5



End setup.
 Press ACTION four times.

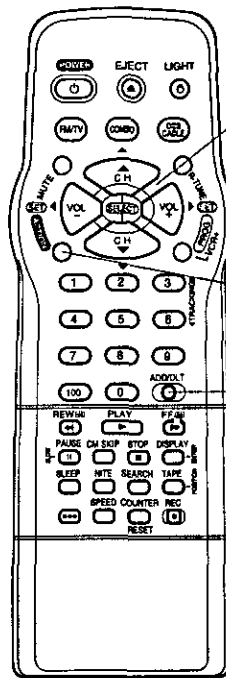

Model PV-C2540 remote is shown here.

Special VCR Features (continued)

Time Stamp Feature

This unit writes program data (see example below) for about the first 10 seconds of every recording. The information is then displayed during the first 10 seconds of playback. To change the data, see "Changing Time Stamp Data" section on next page.

- Check list before you begin.
- The clock is set to correct time.
 - The record tab is in place.

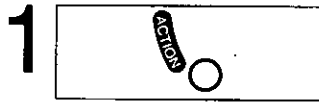

Display MAIN MENU.
Press ACTION*.

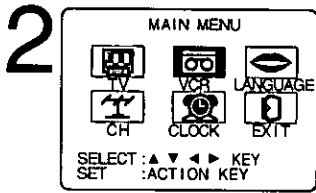

Display SET UP VCR screen.

1) Press ▲▼◀▶ to select "VCR."
2) Press ACTION to display.

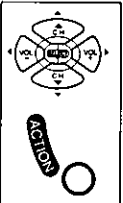
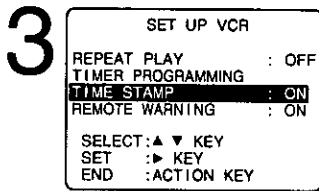
Select TIME STAMP.

1) Press ▲▼ to select.
2) Press ▶ to set "ON" or "OFF."

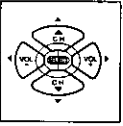

• When "OFF" is selected, the program data is written on the tape, but will not be displayed.



Return to normal screen.
Press ACTION twice.

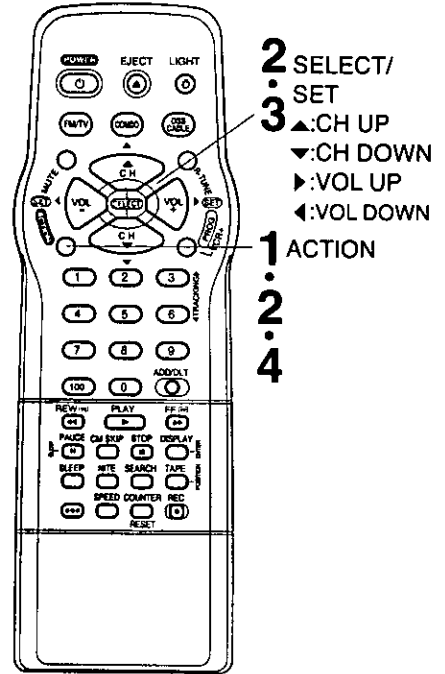

Model PV-C2540 remote is shown here.

<Time Stamp Example >

Normal/ One Touch Recording

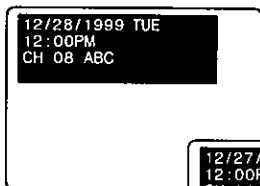

Timer Recording

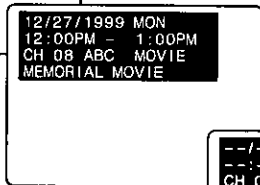

When Clock is not set...

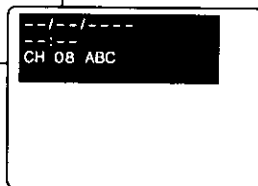

*Important: if the remote control POWER, CH Up/Down, NUMBERED keys, ACTION, PROG/VCR+, DISPLAY, SEARCH, R-TUNE, FM/TV, or ADD/DLT button does not work when pressed, press COMBO button on the remote and try the button again.

Changing Time Stamp Data

You may change the time stamp data (Date, Time, Channel, Category, and Notes) as desired.



Display Time Stamp Data.

- 1) Insert cassette with record tab.
- 2) Press PLAY.

Model PV-C2540 unit is shown here.

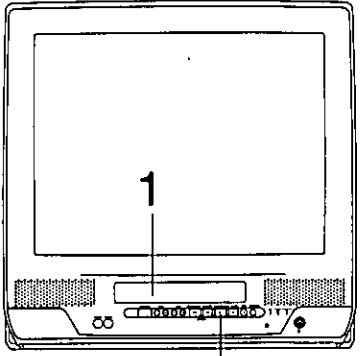

1 PLAY/REPEAT

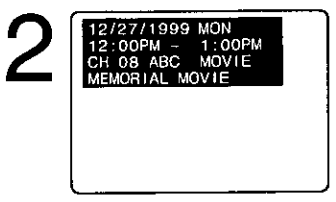

Display TIME STAMP EDIT.



Press **PROG/VCR+** while the data is displayed in playback mode.

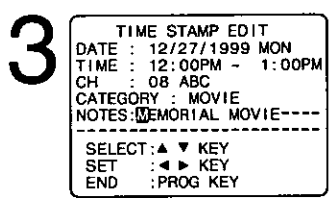

Change Time Stamp Data.

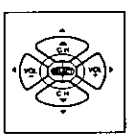

- 1) Press ▲▼ to select.
- 2) Press ► or ◀ to enter and continue.

• Characters in NOTES will change in the following order.

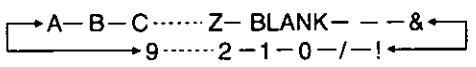

- 3) Repeat 1) and 2) as needed.

To Make Corrections
Press ◀▶ to move to the incorrect entry, then press ▲▼ to make the correction.

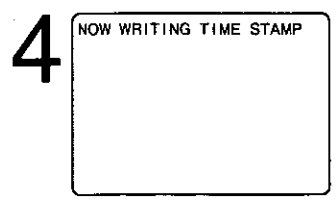

Write the new data.

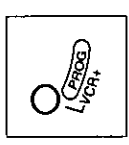

Press **PROG/VCR+**.

- After the data is written, the unit automatically goes into Stop mode.
- You cannot use POWER or REC button while "NOW WRITING TIME STAMP" is displayed.

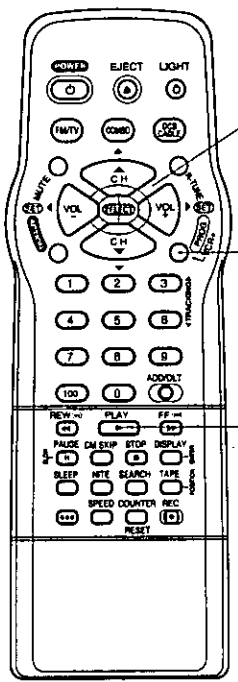

- 3 SELECT/SET
- ▲: CH UP
- ▼: CH DOWN
- : VOL UP
- ◀: VOL DOWN
- 2 PROG/VCR+
- 4
- 1 PLAY

Model PV-C2540 remote is shown here.

Advanced Operation

Special VCR Features (continued)

Weak Signal Display ON/OFF

When "ON" is selected, the picture is displayed even when a broadcast signal is weak or non-existent.

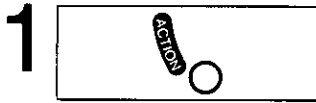

Display MAIN MENU.

Press ACTION*.

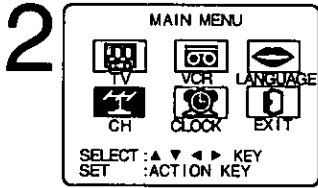

Display SET UP CH screen.

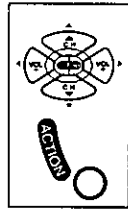

- 1) Press ▲▼◀▶ to select "CH."
- 2) Press ACTION to display.

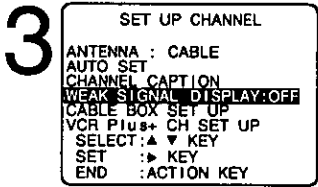

Select WEAK SIGNAL DISPLAY.

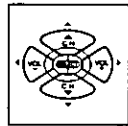

- 1) Press ▲▼ to select.
- 2) Press ▶ to set "ON" or "OFF."

Notes

- "ON" = Picture is displayed regardless of signal condition, and may not always be clearly visible.
- "OFF" = Screen turns solid blue when signal is absent or weak.
- If unit is connected to equipment which has blue back feature, selecting "ON" will have no effect on the other equipment.

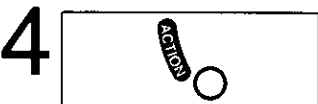

Return to the normal screen.

Press ACTION twice.

VCR Lock

All operations are prohibited except Timer recording and tape eject. Useful for families with small children.

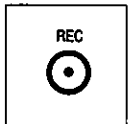
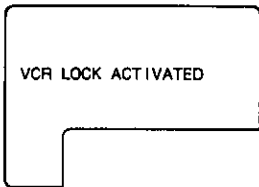

To turn "ON."
In stop mode, hold down REC on the unit without a cassette inserted for 7 seconds.

To turn "OFF."
Repeat above with or without cassette.

- VCR Lock is canceled automatically after about 24 hours if clock is set.

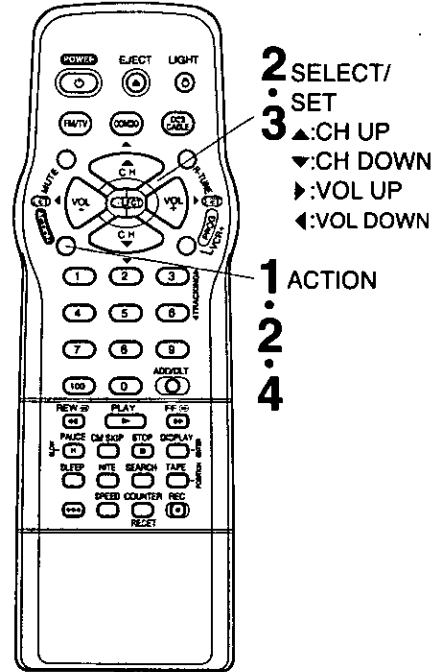

Model PV-C2540 remote is shown here.

Model PV-C2540 unit is shown here.

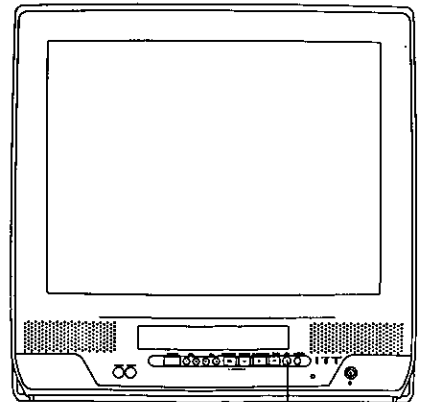

REC

Copy Your Tapes (Dubbing)

Important: if the remote control POWER, CH Up/Down, NUMBERED keys, ACTION, PROG/VCR+, DISPLAY, SEARCH, R-TUNE, FM/TV, or ADD/DLT button does not work when pressed, press COMBO button on the remote and try the button again.

Connections you'll need to make.

<Model PV-C2540 unit is shown here.>

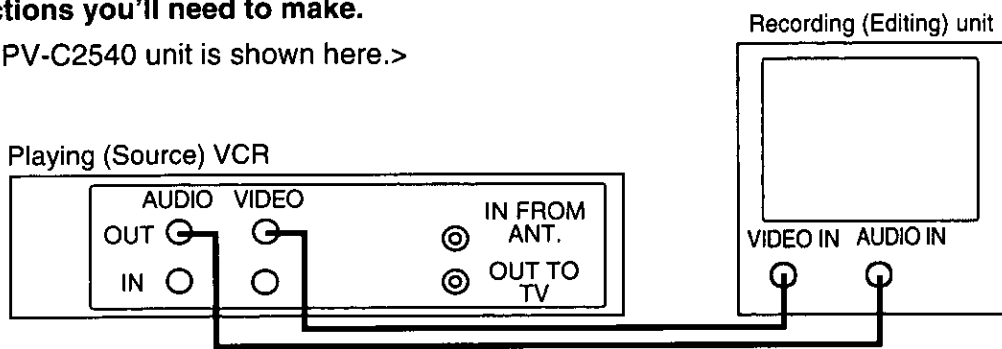

<Model PV-C2580 unit is shown here.>

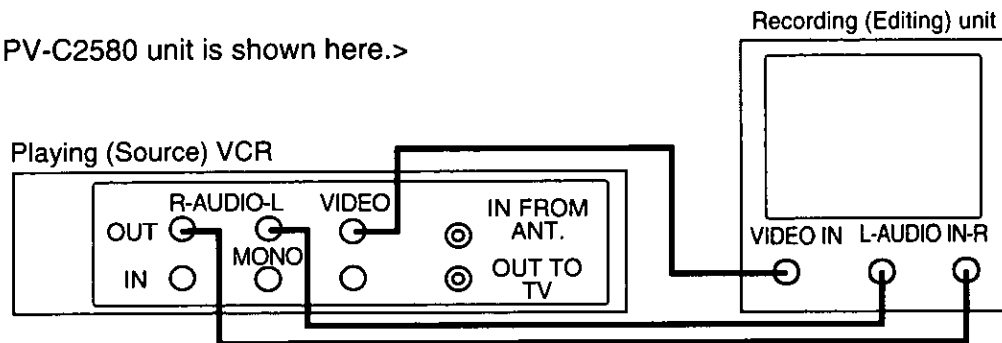

Playback (Source) VCR

Recording (Editing) unit

1  **Insert pre-recorded tape.**

 **Insert blank tape with record tab.**
 • Dubbing tapes protected with Copy Guard will have poor quality results.

2 _____ **Select "LINE" mode.**
 See "Selecting Input Mode" section on page 13.

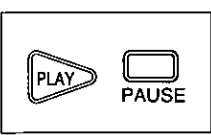
3  **Put in Standby mode.**
 Press PLAY then PAUSE at starting point.

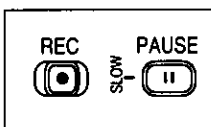
 **Put in Standby mode.**
 Press REC, then PAUSE/SLOW immediately.

4  **Start dubbing.**
 Press PLAY.

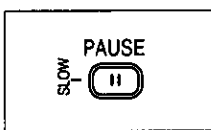
 **Start dubbing.**
 Press PAUSE/SLOW.

5  **Stop dubbing.**
 Press STOP/EJECT.

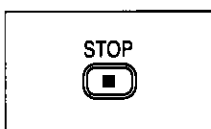
 **Stop dubbing.**
 Press STOP.

Caution

• Unauthorized exchanging and/or copying of copyrighted recordings may be copyright infringement.

FM Radio Setup

1



Display FM radio mode.

Press FM/TV* on the remote or TIMER/FM twice on the unit.

FM Radio is ...

This unit has an FM radio with built-in antenna, 9 station preset, and a band range of 87.5 ~ 108.1 MHz. You can even set the On-Timer (page 20) to wake up to your favorite radio station.

Model PV-C2540 unit is shown here.

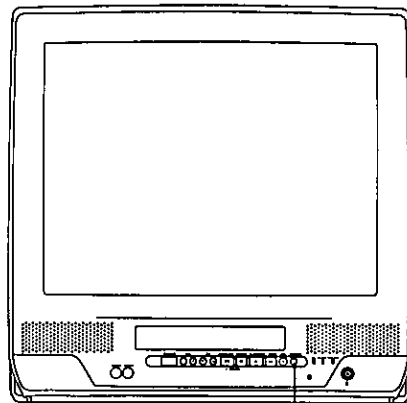

1 TIMER/FM

2

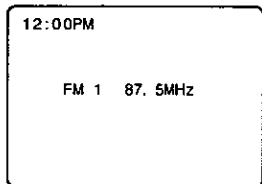

Select the FM number.

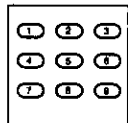

Press a NUMBERED key (1~9.)

3

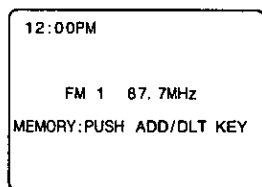

Set the radio station.

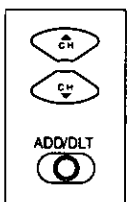

- 1) Press CH ▲▼ to select the desired radio station. (Each press changes frequency 200 kHz.)
- 2) Press ADD/HLT to set.

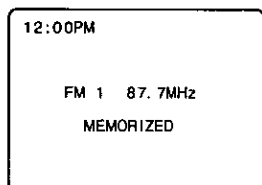

Quick Station Scan

Hold down CH ▲ or ▼ for a few seconds, then release to scan for FM stations in your area.

- To cancel, press CH ▲ or ▼ while in search mode.

To Make Corrections, select station with a NUMBERED key, then do step 3 again.

To exit FM mode, press FM/TV on the remote or TIMER/FM twice on the unit.

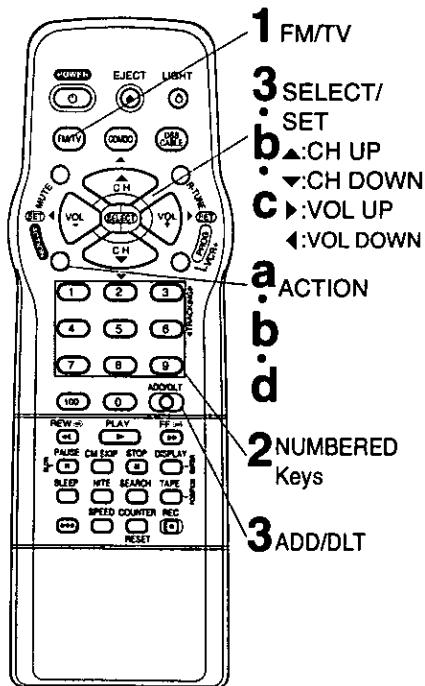

1 FM/TV

3 SELECT/SET

b ▲:CH UP

▼:CH DOWN

c ►:VOL UP

◄:VOL DOWN

a ACTION

b

d

2 NUMBERED Keys

3 ADD/HLT

Model PV-C2540 remote is shown here.

FM ANTENNA Setup

Make sure FM tuning is done correctly (See FM Radio Setup.)

a



Display MAIN MENU.

Press ACTION.

b

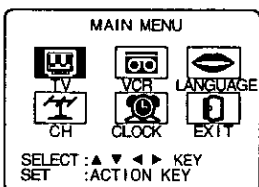

Display SET UP TV screen.

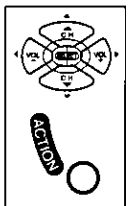

- 1) Press ▲▼◄► to select "TV."
- 2) Press ACTION to display.

Continued on the next page...

•Important: if the remote control POWER, CH Up/Down, NUMBERED keys, ACTION, PROG/VCR+, DISPLAY, SEARCH, R-TUNE, FM/TV, or ADD/HLT button does not work when pressed, press COMBO button on the remote and try the button again.

C

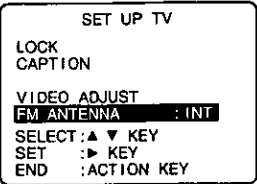

Select FM ANTENNA.

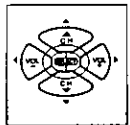

- 1) Press ▲▼ to select.
- 2) Press ► to select "INT (INTERNAL)" or "EXT (EXTERNAL)" whichever sounds the best.

<For Model PV-C2540 only>

- For cable TV users → "INT"
- For antenna users → "EXT"

d



End setup.
Press ACTION twice to exit.

Model PV-C2540 unit is shown here.

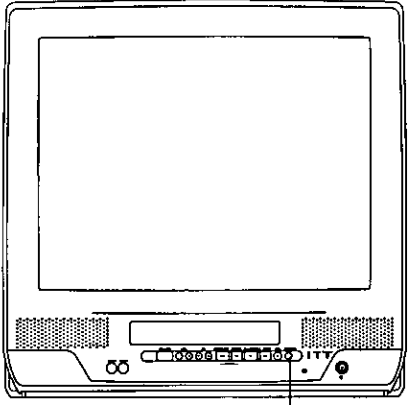

A TIMER/FM

Using FM Radio

A



Display FM radio mode.
Press FM/TV on the remote or TIMER/FM twice on the unit.

B

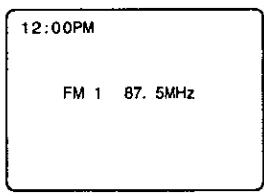

Select the FM number.

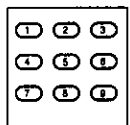

Press a NUMBERED key (1~9) to select a preset station (see steps 2 and 3 on the previous page.)

To cancel, press FM/TV on the remote or TIMER/FM twice on the unit.

Notes

Once stations are set, the selected station and current time are displayed when FM Radio mode is entered. To remove time, press DISPLAY. If DISPLAY is pressed, the unit status screen appears.

<For Model PV-C2580 only>
To select Audio Mode for FM Radio

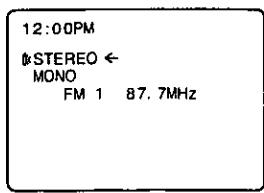

Select "STEREO" or "MONO."



Press AUDIO repeatedly in FM Radio mode.

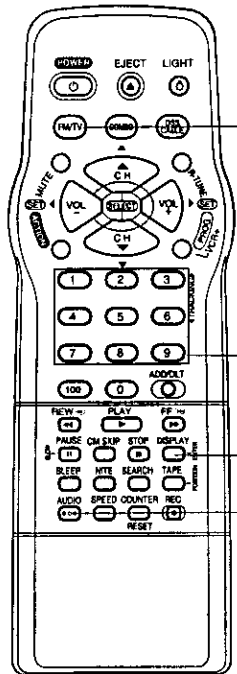

A FM/TV

B NUMBERED Keys

C DISPLAY

D AUDIO

Model PV-C2580 remote is shown here.

Notes

- FM radio cannot be recorded on a Video cassette.
- You may get better reception by repositioning the unit.
- You cannot select FM Radio mode during playback or record, or while a blue back screen (PROG, ACTION, MENU) is displayed.

Advanced Operation

FM Transmitter

FM Transmitter is ...

a feature whereby this unit's sound signal can be heard on your FM Radio. First, tune your radio to a frequency (93 ~ 97, 99 ~ 103 MHz) that is not being broadcast on by a radio station. Then, set this unit to the same carrier frequency (see below.) Now, fine-tune this unit so the sound comes in clearly.

FM Transmitter Carrier Frequency Setup

1  **Display MAIN MENU.**
Press ACTION*.

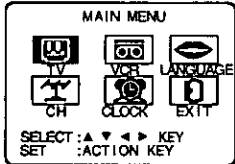
2  **Display SET UP TV screen.**

1) Press \blacktriangle \blacktriangleright \blacktriangleleft \blacktriangle to select "TV".
2) Press ACTION to display.

3  **Select SET UP FM.**

1) Press \blacktriangle \blacktriangleright to select.
2) Press \blacktriangleright to display.

4  **Select SET UP FM TRANSMITTER.**

1) Press \blacktriangle \blacktriangleright to select.
2) Press \blacktriangleright to display.

* When step 4 is done, FM TRANSMITTER is automatically set to "ON."

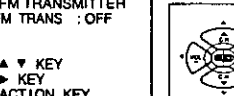
5  **Set the Carrier Frequency.**

1) Press \blacktriangle \blacktriangleright to select the desired frequency range. (93-97 or 99-103MHz)
2) Press \blacktriangleleft \blacktriangleright to select the Carrier Frequency.
3) Press ACTION to set. (Then screen in step 4 is redisplayed.)

To Make Corrections, select frequency with CH \blacktriangle \blacktriangleright \blacktriangleleft \blacktriangle , then repeat step 5.

6  **End setup**
Press ACTION three times.

<For Model PV-C2580 only>

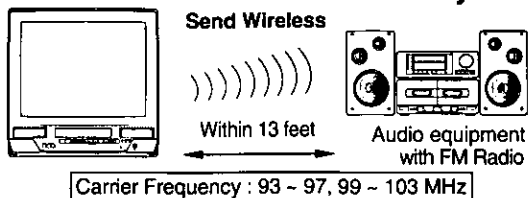

FM Transmitter ON/OFF

1 Do "FM Transmitter Carrier Frequency Setup" steps 1~3. (See left.)

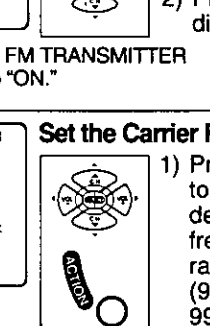
2  **Select SET UP FM TRANSMITTER.**

1) Press \blacktriangle \blacktriangleright to select.
2) Press \blacktriangleright to set "ON" or "OFF."

3  **End setup**
Press ACTION three times.

Speaker with FM Transmitter ON/OFF

1 Do "FM Transmitter Carrier Frequency Setup" steps 1~3. (See left.)

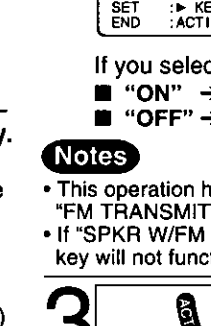
2  **Select Speaker with Transmitter.**

1) Press \blacktriangle \blacktriangleright to select.
2) Press \blacktriangleright to set "ON" or "OFF."

If you select...

- "ON" → Internal Speaker ON with Transmitter
- "OFF" → Internal Speaker MUTE with Transmitter

Notes

- This operation has effect only when "FM TRANSMITTER : ON" (see above.)
- If "SPKR W/FM TRANS : OFF", the MUTE and VOLUME key will not function.

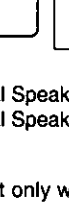
3  **End setup**
Press ACTION three times.

Notes

- The Carrier Frequency shown by the selector bar is a guide only. Please listen to the sound and adjust accordingly.
- The unit will transmit sound when unit power is on and "FM TRANSMITTER : ON" is selected.
- When unit power is turned off, "FM TRANSMITTER" returns to "OFF" setting.
- Please put your FM Radio within 13 feet of the unit.
- Interference occurs when you select CATV channels 95, 96, or 97, while FM Transmitter is operating.
- FM Transmitter will not work in FM Radio Mode.
- This is a Stereo Signal transmitted to the Stereo receiver of FM radio.
- The Stereo receiver or the FM radio must have a FM Internal Antenna or this feature will not work.

Picture Adjustment

Important: if the remote control POWER, CH Up/Down, NUMBERED keys, ACTION, PROG/VCR+, DISPLAY, SEARCH, R-TUNE, FM/TV, or ADD/HLT button does not work when pressed, press COMBO button on the remote and try the button again.

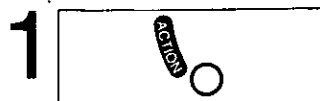

Display MAIN MENU.
Press ACTION.

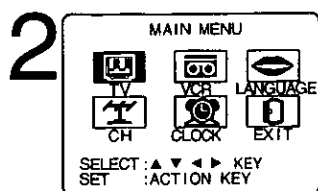

Display SET UP TV screen.

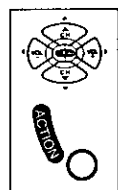

- 1) Press ▲▼◀▶ to select "TV."
- 2) Press ACTION to display.

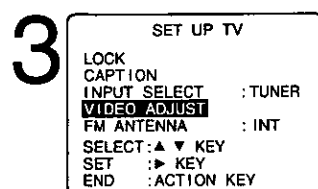

Display VIDEO ADJUST screen.

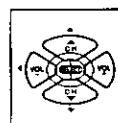

- 1) Press ▲▼ to select.
- 2) Press ▶ to display.

<For Model PV-C2540 only>

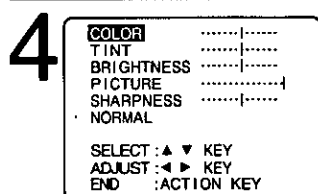

Adjust desired item.

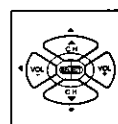

- 1) Press ▲▼ to select an item. (See below right.)
- 2) Press ◀▶ to adjust.

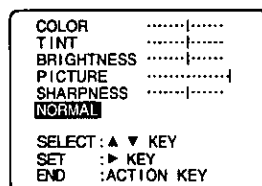

To Reset Picture Controls:

Press ▲▼ and ▶ to select and set "NORMAL."
All controls return to their factory settings.

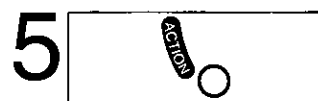

End setup.
Press ACTION three times to exit.

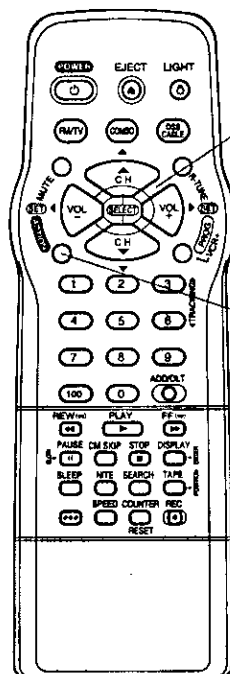

- 2 SELECT/SET
- 3 ▲:CH UP
▼:CH DOWN
- 4 ▶:VOL UP
◀:VOL DOWN
- 1 ACTION
- 2
3
5

Model PV-C2540 remote is shown here.

Advanced Operation

Picture Adjustment

- **COLOR Control**
Adjust color intensity.
- **TINT Control**
Adjust for natural flesh tones.
- **BRIGHTNESS Control**
Adjust picture brightness.
- **PICTURE Control**
Adjust picture intensity by adjusting both contrast and color level in the proper balance.
- **SHARPNESS Control**
Adjust picture sharpness.

V-Chip Control Feature

V-Chip Control Feature is...

This unit has a built-in V-Chip Control which allows you to block unwanted TV usage based on US MOVIES and US TV PROGRAMS ratings.

Process of V-Chip Control Feature

Enter Code → Setup → Blocking

Enter Secret Code

A 4-digit code must be entered to view a blocked program or change rating settings.



Display MAIN MENU.

Press ACTION*.

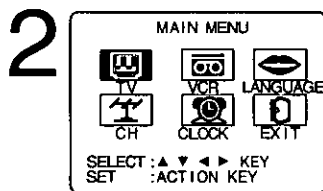

Display SET UP TV screen.

- 1) Press ▲▼◀▶ to select "TV."
- 2) Press ACTION to display.

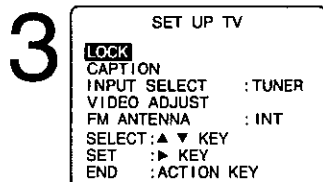

Select Lock.

- 1) Press ▲▼ to select.
- 2) Press ▶ to display.

<For model PV-C2540 only>

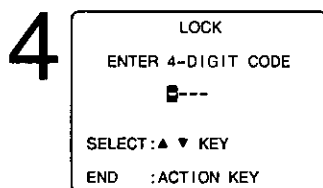

Enter your secret code.

- 1) Press ▲▼ to select a number.
- 2) Press ▶ (or ◀) to set.

To Make Corrections

Press ◀▶ to move the cursor and ▲▼ to make the correction.

- Repeat step 4 until all 4-digits are entered.
- Take care that you are not observed entering the secret code.

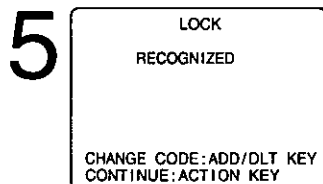

Save 4-DIGIT CODE.

Press ACTION.



Display LOCK menu for rating screen.

Press ACTION and go to page 39 (US MOVIES Ratings), or page 40 (US TV PROGRAMS Ratings) OR to exit, press ACTION four times.

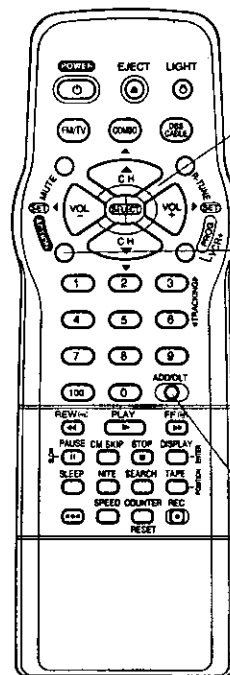

- 2 SELECT/SET
 - 3 ▲:CH UP
 - 4 ▼:CH DOWN
 - ▶:VOL UP
 - ◀:VOL DOWN
 - 1 ACTION
 - 2
 - 5
 - 6
- ADD/DLT

Model PV-C2540 remote is shown here.

Changing your secret code

- You will need your current code.

Do steps 1~4. In step 5, press ADD/DLT to clear current code. Repeat steps 4 and 5 to enter new code.

Notes

- DO NOT forget your secret code.
- Once rating are set, restricted tapes or programs cannot be accessed unless the secret code is entered.

*Important: if the remote control POWER, CH Up/Down, POWER, ACTION, PROG/VCR+, DISPLAY, SEARCH, R-TUNE, FM/TV, or ADD/HLT button does not work when pressed, press COMBO button on the remote and try the button again.

Setup US MOVIES Ratings

If LOCK menu is not displayed, do "Enter Secret Code" steps on page 38.

1

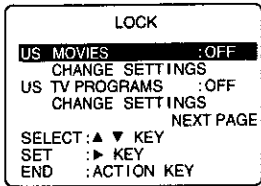

Select US MOVIES STATUS.

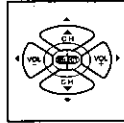

- 1) Press ▲▼ to select.
- 2) Press ► to set "ON" or "OFF."

If you select US MOVIES STATUS:

- "ON" → V-Chip Control is activated.
- "OFF" → V-Chip Control is deactivated.

Notes

- "NEXT PAGE" is setup to CANADIAN V-Chip setting mode. "NEXT PAGE" cannot be used in the U.S.

2

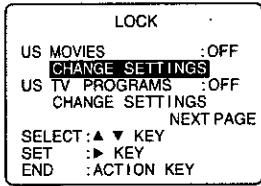

Select CHANGE SETTINGS.

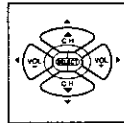

- 1) Press ▲▼ to select.
- 2) Press ► to display.

3

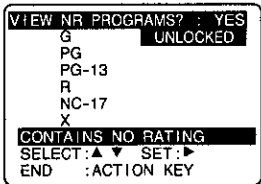

Select VIEW NR PROGRAMS?

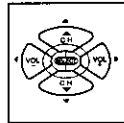

- 1) Press ▲▼ to select.
- 2) Press ► to set "YES" or "NO."

NR (Not Rated) PROGRAMS

Some movies, such as old movies or foreign movies usually have no ratings.

4

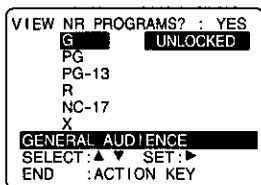

Select ratings to be blocked. (See right.)

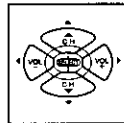

- 1) Press ▲▼ to select.
- 2) Press ► to set.

5



Redisplay LOCK menu to continue setup.

Press ACTION and go to page 40 (US TV PROGRAMS Ratings) OR to exit, press ACTION four times.

Process of V-Chip Control Feature

Enter Code → Setup → Blocking

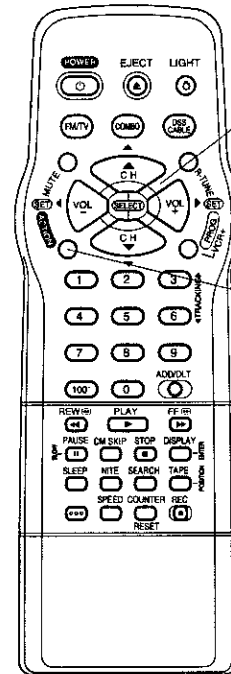

1. SELECT/SET
2. ▲:CH UP
3. ▼:CH DOWN
4. ►:VOL UP
5. ACTION

Model PV-C2540 remote is shown here.

US MOVIES RATINGS

G	GENERAL AUDIENCE: All ages admitted.
PG	PARENTAL GUIDANCE: Some material may not be suitable for children.
PG-13	PARENTS CAUTIONED: Some material may be inappropriate for children under 13.
R	RESTRICTED: Children under 17 must be accompanied by a parent or adult.
NC-17	OVER AGE 17 ONLY: No one 17 and under admitted.
X	ADULTS ONLY:

V-Chip Control Feature (continued)

Setup US TV PROGRAMS Ratings

If LOCK menu is not displayed, do "Enter Secret Code" steps on page 38.

1

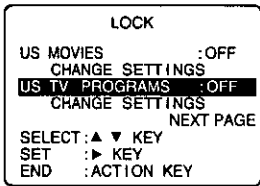

Select US TV PROGRAMS STATUS.

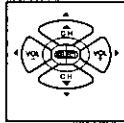

- 1) Press ▲▼* to select.
- 2) Press ► to set "ON" or "OFF."

If you select US TV PROGRAMS STATUS:

- "ON" → V-Chip Control is activated.
- "OFF" → V-Chip Control is deactivated.

Notes

- "NEXT PAGE" is setup to CANADIAN V-Chip setting mode. "NEXT PAGE" cannot be used in the U.S.

2

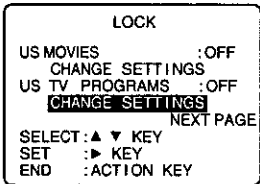

Select CHANGE SETTINGS.

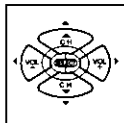

- 1) Press ▲▼ to select.
- 2) Press ► to display.

3

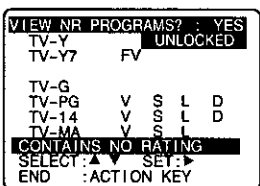

Select VIEW NR PROGRAMS?

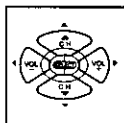

- 1) Press ▲▼ to select.
- 2) Press ► to set "YES" or "NO."

NR (Not Rated) PROGRAMS

Some TV shows, such as news, sports, weather, bulletins, emergency information usually have no ratings.

4

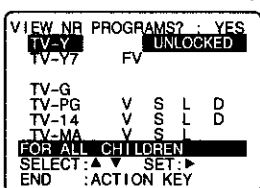

Select ratings to be blocked. (See next page.)

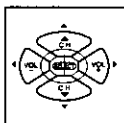

- 1) Repeatedly Press ▲▼ to select.
- 2) Press ► to set.

Note

You may select from standard TV ratings (chart 1), or customize to a specific content rating (chart 2.)

- Ratings which are highlighted in Green will be blocked, when not highlighted (white letters), these will not be blocked.

5



Exit this mode.

Press ACTION four times.

40

For assistance, call 1-800-211-PANA(7262)

Process of V-Chip Control Feature

Enter Code → Setup → Blocking

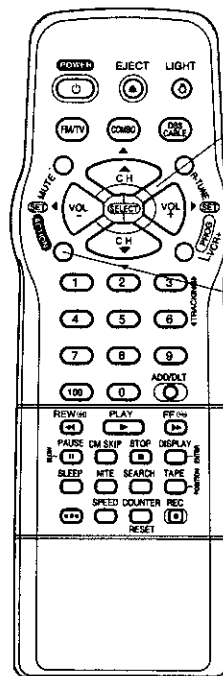

1. SELECT/SET
2. ▲:CH UP
3. ▼:CH DOWN
4. ►:VOL UP
5. ACTION

Model PV-C2540 remote is shown here.

*Important: if the remote control POWER, CH Up/Down, NUMBERED keys, ACTION, PROG/VCR+, DISPLAY, SEARCH, R-TUNE, FM/TV, or ADD/HLT button does not work when pressed, press COMBO button on the remote and try the button again.

**US TV PROGRAMS RATINGS:
Chart 1**

TV-Y	FOR ALL CHILDREN: Content specifically geared to young viewers ages 2-6.
TV-Y7	FOR AGE 7 AND OLDER: May contain mild physical or comedic violence which may frighten children under 7.
TV-G	GENERAL AUDIENCE: Contains little or no violence, strong language, or sexual dialogue or situations.
TV-PG	PARENTAL GUIDANCE: May contain infrequent coarse language, limited violence, some suggestive sexual dialogue and situations.
TV-14	PARENTS CAUTIONED: May contain sophisticated themes, sexual situations, strong language, and more intense violence.
TV-MA	MATURE AUDIENCE: May contain mature themes, profane language, graphic violence, and sexual situations.

**US TV PROGRAMS RATINGS:
Chart 2**

FV	Fantasy Violence
V	Violence
S	Sexual Situations
L	Adult Language
D	Sexually Suggestive Dialogue

Process of V-Chip Control Feature

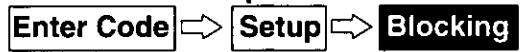

Blocking Message

<When V-Chip Control is activated>

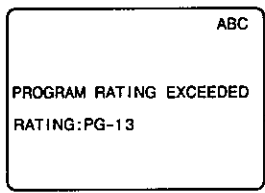

- If V-Chip Control is activated, and a program or movie exceeds the ratings you have set, a message will appear on a black background and sound is muted.

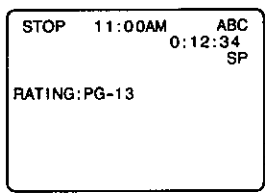

- If DISPLAY is pressed, even when V-Chip control is deactivated, rating is displayed on-screen.

To Continue Viewing a Blocked Program

After entering your 4-digit secret code, go to step 1 on both pages 39 and 40 and select "OFF" to deactivate V-Chip Control.

- The US MOVIES and US TV PROGRAMS ratings you set will be retained.

Advanced Operation

Cable Box Universal Remote Control Feature

The Universal Remote Control Setup

1 Find your DSS box or Cable box Brand Code Number from one of the charts on the next page.

2

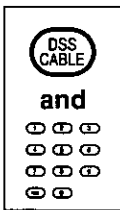

Setup remote.

- 1) Hold down DSS CABLE.
- 2) Press NUMBERED keys to enter code.

- For code 100 or greater, first press 100 key, then the remaining digit. E.g. for 102, press 100, then press 0, and then press 2.

3

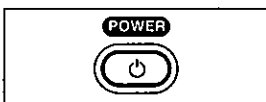

Confirm code entry.

Press POWER* to turn selected unit ON or OFF.

- See below for a list of controllable functions in each mode.

Notes

- Please repeat the Universal Remote Control Setup after replacing remote control batteries.
- The remote control will not operate all DSS receivers or Cable Boxes made by the manufacturers listed. If you get no results, your particular brand cannot be controlled.

Using the Universal Remote Control

Once the remote control has been properly set up, you can select COMBO, DSS or CABLE mode depending on which functions you wish to control. (See below.)

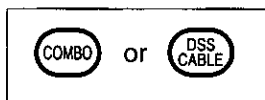

Press COMBO or DSS CABLE on the remote control to select the desired mode. (See below for buttons available in each mode.)

Set to COMBO:

- All TV and VCR functions.

Set to DSS CABLE:

- Basic VCR functions, e.g. PLAY, REC, etc.
- CABLE/DSS functions, e.g. POWER, ENTER, NUMBERED keys (except 100key), CH UP/DOWN.

Notes

- In DSS or CABLE mode, it may be necessary to press ENTER after pressing NUMBERED keys for channel selection.
- In DSS or CABLE mode, POWER, CH Up/Down, NUMBERED Keys, ACTION, PROG/VCR+, DISPLAY, SEARCH, R-TUNE, FM/TV, or ADD/HLT are not available. Press COMBO to use these functions.
- Depending on your DSS receiver or Cable box brand, some of the functions listed may not be remote controllable.
- Some DSS receiver or Cable box brands require you to turn on the power manually.
- Due to changes in infra-red commands used by manufacturers, some brands have several codes. If your unit does not respond to the first code, please try the next one.

Universal Remote Control is...
The Remote Control may be set up to control some basic DSS or Cable box functions.

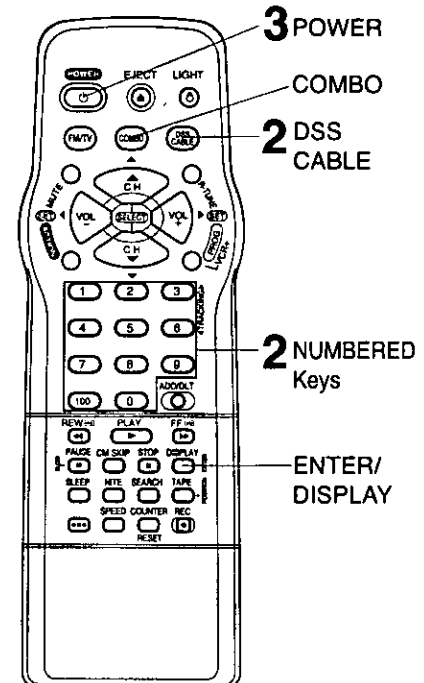

Model PV-C2540 remote is shown here.

if the **COMBO** button is pressed. **CH UP/Down**, **CH** button does not work when pressed. press **COMBO** button on the remote and try the button again.

Remote Warning ON/OFF

When Universal Remote Control (previous page) is used, and this feature is set to "ON," a warning appears whenever an invalid key is pressed in DSS or Cable mode.



1 Display MAIN MENU.
Press ACTION.

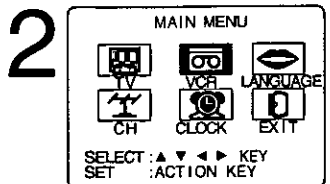

2 Display SET UP VCR screen.
1) Press ▲▼◀▶ to select "VCR."
2) Press ACTION to display.

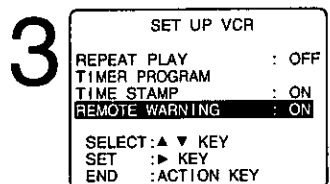

3 Select REMOTE WARNING.
1) Press ▲▼ to select.
2) Press ▶ to set "ON" or "OFF."

• "OFF" → Remote warning will not appear even if invalid key is pressed.

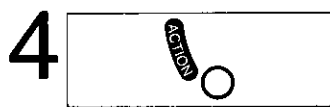

4 Return to normal screen.
Press ACTION twice.

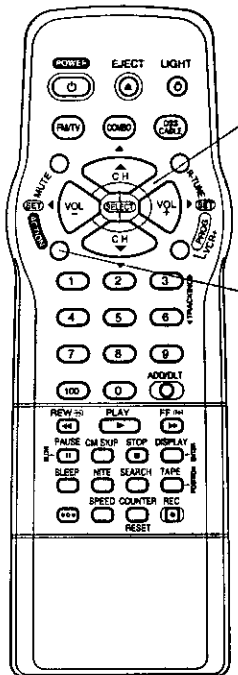

Model PV-C2540 remote is shown here.

Advanced Operation

DSS Brand Code Numbers

Toshiba	92	Magnavox/Uniden 2	95	Sony	98, 105
Hitachi/Hughes	93	Panasonic	96		
Magnavox/Uniden 1	94	RCA	97		

Cable Box Brand Code Numbers

Archer	05, 06, 01, 44, 63, 91, 126	Matsushita	16, 17, 97, 109	Sheritech	27
Cabletenna	01, 44, 63, 91, 126	Movietime	32, 39, 42, 44, 126, 38, 40	Signal	26, 112
Cableview	63, 44, 42, 30, 52, 04, 124, 126	NEC	38, 40, 32	SL Marx	32, 40, 42, 06, 43, 44, 52, 63, 126
Century	51, 44, 59, 75, 126	NOVAVISION	08, 09, 61, 53, 87	Sprucer	16, 17, 97, 109
Citizen	63, 44, 42, 30, 52, 04, 124, 126	NSC	38, 40, 32	Standard Components ..	32, 39, 42, 44, 126
Curtis	08, 09, 61, 53, 87	Oak	46, 11, 129	Stargate ..	32, 40, 63, 44, 42, 30, 52, 04, 06, 124, 126
Diamond	01, 44, 63, 91, 126, 67	Oak Sigma	46, 11, 129	Sylvania	19
Drake	67	Panasonic	16, 17, 97, 109	Teknika	74
Eagle	13, 22, 58, 62, 20, 40, 26, 107	Philips	07, 13, 20, 23, 24, 50, 128, 129	Tocom	77, 127
Eastern	28, 130	Pioneer	05, 06	Television	32, 40, 42, 06
GC Brand ..	63, 44, 42, 30, 52, 04, 124, 126	Pulsar	63, 44, 42, 30, 52, 04, 124, 126	Texscan	18, 19
Gemini	04, 124	Quest	05, 06	Tocom	33, 34, 01, 42, 66, 91
General Electric	57, 01	Radio Shack	51, 44, 59, 75, 126	Toshiba	36
General Instruments	01, 02, 03, 04, 34, 55, 83, 106, 65, 67, 68, 115, 117, 118	RCA	16, 17, 97, 109	Uniden Satellite	65
Hamlin	14, 15, 28, 41, 102, 103, 104, 108, 130	Realistic	51, 44, 59, 75, 126	Unika	01, 44, 63, 91, 126
Hitachi	31	Recoton	51, 44, 59, 75, 126	Universal	42, 43, 44, 52, 63, 126
Jasco	04, 124	Regal	14, 15, 28, 41, 102, 103, 104, 108, 130	Videoway	07, 23, 50, 129
Jerrold	01, 02, 03, 04, 34, 55, 83, 106, 65, 67, 68, 115, 117, 118	Regency	28, 130	Vid Tech	64
Macom	31	Rembrandt	01, 32, 39, 42, 44, 63, 126	Vidtek	64
Magnavox	26, 112	Salora	68	Viewstar	13, 22, 58, 62, 20, 40, 26, 107
		Samsung	05, 32, 40, 42, 06	Zenith	07, 23, 50, 129
		Scientific Atlanta	08, 09, 61, 53, 87		

Audio Features

<For Model PV-C2580 only>

Select Audio Mode for Playback

Choose the type of sound track for playback.

1 Playback the tape.

See the "Playback a Tape" section on page 12.

2

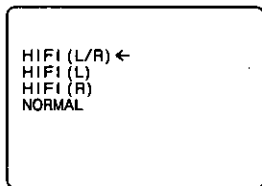

- This screen appears when you press AUDIO during playback.

Select desired mode.



Press AUDIO repeatedly (each press within 5 seconds.)

- Please select "HIFI (L/R)", "HIFI (L)" or "HIFI (R)" to listen to stereo recordings in stereo sound. Select "NORMAL" for monaural sound.

Select Audio Mode for Recording

Choose the type of broadcast to be recorded.

a



Select Audio Mode for Recording a Do "Select Audio Mode for TV Viewing" steps on page 11. Press AUDIO.

- Recording will always be made in the audio mode selected in the "Select Audio Mode for TV Viewing" section on page 11.

b

Do a recording.

See the "Record On a Tape" section on page 13.

With the proper audio mode setting, your unit can:

- record and playback MTS stereo broadcast (main language) in stereo Hi-Fi. Stereo sound is recorded on the left and right audio tracks and on the video portion of a tape.
- record and playback a monaural broadcast (main language) or SAP (Secondary Audio Program, usually in a second language) on the Hi-Fi tracks for better quality monaural sound.
- playback non-Hi-Fi tapes in monaural.

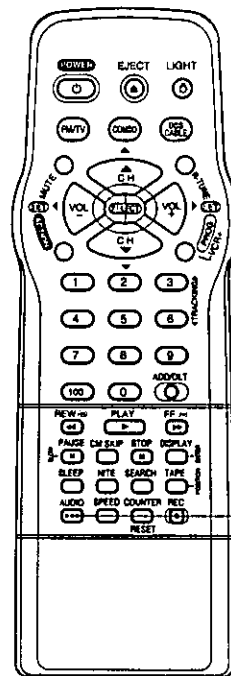

Model PV-C2580 remote is shown here.

Notes

- When purchasing or renting prerecorded tapes, remember that only those recorded in Hi-Fi stereo will playback with true stereo sound. Standard stereo tapes will playback with monaural sound.
- To listen to the superior sound of Hi-Fi stereo playback, the unit AUDIO (L/R) jacks must be connected to a stereo amp and speakers.
- There may be a difference in audio level between Hi-Fi and normal audio playback.

*Important: if the remote control POWER, CH Up/Down, NUMBERED keys, ACTION, PROG/VCR+, DISPLAY, SEARCH, R-TUNE, FM/TV, or ADD/HLT button does not work when pressed, press COMBO button on the remote and try the button again.

<For Model PV-C2580 only>

Speaker ON/OFF System

Allows you to turn off the speaker of the unit when it is connected to external audio equipment.

1  **Display MAIN MENU.**
Press ACTION*.

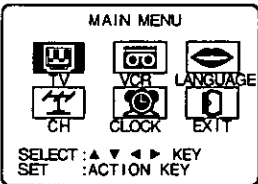
2  **Display SET UP TV screen.**

1) Press ▲▼◀▶ to select "TV."
2) Press ACTION to display.

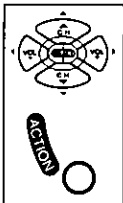

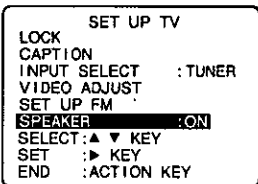
3  **Select SPEAKER.**

1) Press ▲▼ to select.
2) Press ▶ to set "ON" or "OFF."

• In SPEAKER OFF condition, the MUTE button and VOL + - do not function.

4  **End setup.**
Press ACTION twice.

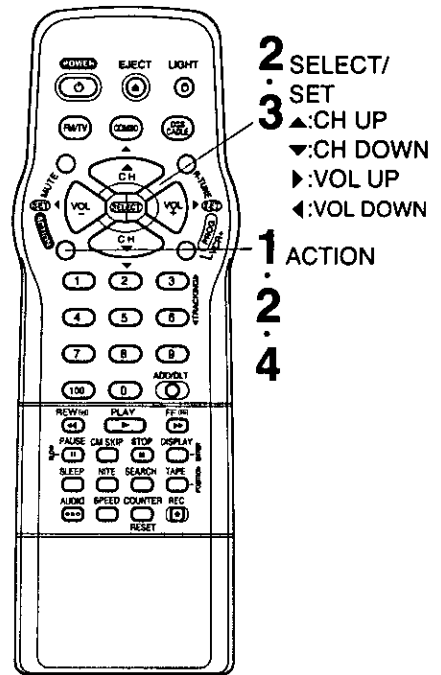

Model PV-C2580 remote is shown here.

To Change the OSD Language

1  **Display MAIN MENU.**
Press ACTION*.

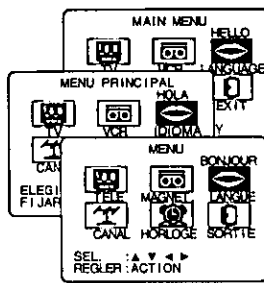
2  **Select the language selection icon.**

- 1) Press ▲▼◀▶ to select.
- 2) Press ACTION repeatedly to set.

English:LANGUAGE
Spanish:IDIOMA
French:LANGUE

3  **End setup.**

- 1) Press ▲▼◀▶ to select "EXIT."
- 2) Press ACTION to exit.

To Replace Channels in Memory

1  **Display MAIN MENU.**
Press ACTION.

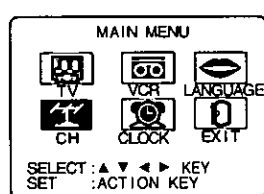
2  **Display SET UP CH screen.**

- 1) Press ▲▼◀▶ to select "CH."
- 2) Press ACTION to display.

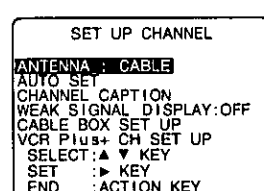
3  **Select ANTENNA.**

- 1) Press ▲▼ to select.
- 2) Press ▶ to select your antenna system ("TV" or "CABLE.")

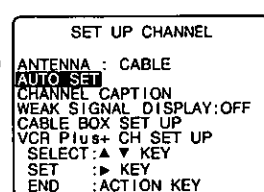
4  **Select AUTO SET.**

- 1) Press ▲▼ to select.
- 2) Press ▶ to start.

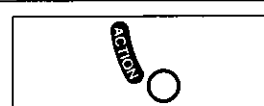
5  **End setup.**
Press ACTION twice.

To Set or Reset the Clock

1  **Display MAIN MENU.**
Press ACTION.

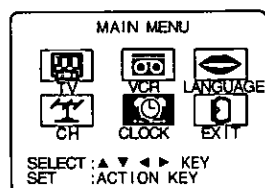
2  **Display SET CLOCK screen.**

- 1) Press ▲▼◀▶ to select "CLOCK."
- 2) Press ACTION.

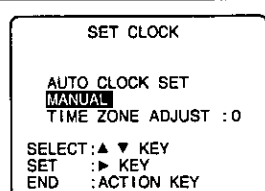
3  **Display SET CLOCK menu.**

- 1) Press ▲▼ to select "MANUAL."
- 2) Press ▶ to set.

- For Auto Clock Set, select "AUTO CLOCK SET" then press ▶ to set and CH ▲ to start.

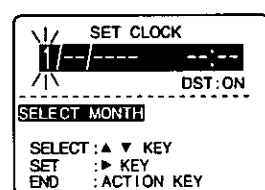
4  **Set the clock manually.**

- 1) Press ▲▼ to select the month.
- 2) Press ▶ to set.

- Likewise set date, year, time, and DST. (Daylight Saving Time.)

To Make Corrections, repeatedly press ◀▶ to move to error, then correct.

5  **End setup.**
Press ACTION twice to start the clock and exit this mode.

Add or Delete a Channel

To add channel:
Select channel with NUMBERED keys and press ADD/HLT.

CHANNEL 08 ADDED

To delete channel:
Select channel with CH ▲▼ or NUMBERED keys and press ADD/HLT.

CHANNEL 08 DELETED

On-Screen Display (OSD)

VCR Status & Clock Display



To display or remove the overlay.
Press DISPLAY.

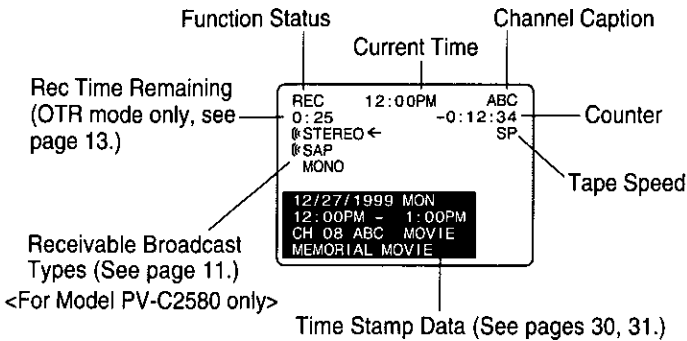

Blue Screen Display

Whenever a blank section of a tape comes up in Play mode, or when the selected channel has no broadcast signal with the "Weak Signal Display ON/OFF" (see page 32) set to "OFF," the TV screen will turn solid blue.

Channel & Function Display

When a function button is pressed (PLAY, FF, etc.) or you change channels, the unit mode or channel number will be displayed.
(Some station names may also appear if Channel Caption is set. See pages 28, 29.)

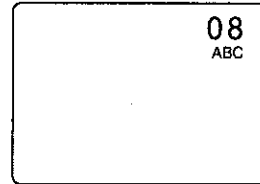

Warning and Instruction Displays

These displays will alert you of a missed operation or provide further instructions.

OSD	Caution	Page
NO CH FOUND PLEASE CHECK ANTENNA CABLE CONNECTION THEN PUSH CH UP KEY AGAIN	• If no active channels are found for CHANNEL MEMORY...	7
PLEASE SET CLOCK BEFORE PROGRAMMING	• If you attempt to set or review a Timer Recording, VCR Plus+ System Programming or set the On-Timer and the Clock is not set...	8, 9, 46
CHECK CASSETTE RECORD TAB	• If you press REC, and a cassette is inserted with no record tab...	6, 13
TO CANCEL TIMER REC HOLD DOWN STOP KEY FOR APPROX 3 SEC	• If you press STOP during a Timer Recording...	15
NO CASSETTE PLEASE INSERT A CASSETTE	• If you press PLAY, FF, REW, or REC without a cassette inserted...	12, 13
REMOTE CONTROL IS SET TO DSS/CABLE MODE USE COMBO : COMBO KEY	• If you press POWER, ACTION, or PROG on the remote while in DSS or CABLE mode...	42, 43
VIDEO HEADS MAY NEED CLEANING PLEASE INSERT HEAD CLEANING CASSETTE OR REFER TO MANUAL END: PLAY KEY	• If head cleaning becomes necessary while playing back a tape...	48
VCR LOCK ACTIVATED	• If you press a function button other than STOP/EJECT or POWER while the unit is in VCR Lock mode...	32

Unit Information

Reset all unit Memory Functions

Use when moving unit to a new location, or if a mistake was made in the One Time Setup section.

- Make sure a tape is not inserted in the unit.

<Model PV-C2540 unit is shown here.>

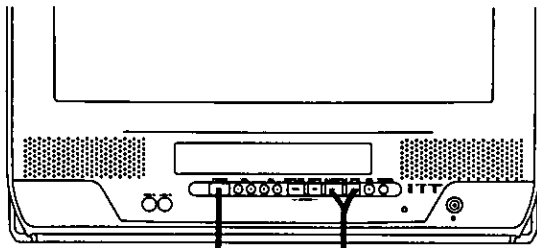

- 1 Turn the unit Power on.
- 2 Press and hold both PLAY and FF on the unit for more than 5 seconds.
 - The power will shut off.
- 3 Do "One Time Setup" steps on page 8.

DST (Daylight Saving Time)

Unit auto adjusts clock for DST (Daylight Saving Time.)

Spring (First Sunday in April)

DST:ON → Sets clock ahead one hour.

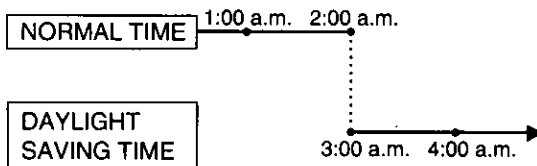

Autumn (Last Sunday in October)

DST:ON → Turns clock back one hour.

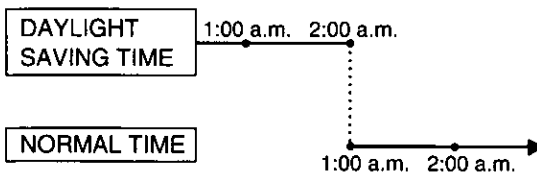

- If your area does not observe Daylight Saving Time, select DST : OFF.
- Keep these time changes in mind when programming the unit for timer recordings.

Head Cleaning

Playing older or damaged tapes may eventually cause video heads to become clogged.

Head Clog Sensor

During playback this screen appears if clogging is detected. To remove screen, press PLAY on the remote or unit.

- Use "dry" type head cleaning cassette only.

(Part No. NV-TCL30PT is recommended.)

- Follow cleaning tape directions carefully. Excessive use of head cleaning tape can shorten the video head life.
- If head clog symptoms persist, contact your nearest Factory Service Center or authorized Service Center. (See Page 50.)

VIDEO HEADS MAY
NEED CLEANING
PLEASE INSERT HEAD
CLEANING CASSETTE
OR REFER TO MANUAL

END:PLAY KEY

Specifications

Display

Picture Tube: 25 inch measured diagonal
110° deflection Picture Tube

VCR

Video Recording System: 4 rotary heads helical scanning system
Audio Track: 1 track (NORMAL)
2 channel (Hi-Fi Audio Sound) (PV-C2580)

Tuner

Broadcast Channels: VHF 2 ~ 13, UHF 14 ~ 69
CABLE Channels: Midband A through I (14 ~ 22)
Superband J through W (23 ~ 36)
Hyperband AA ~ EEE (37 ~ 64)
Lowband A-5 ~ A-1 (95 ~ 99)
Special CABLE channel 5A (01)
Ultraband 65 ~ 94, 100 ~ 125

FM Radio

Band range: 87.5 ~ 108.1 MHz
FM Transmitter
Band range: 93 ~ 97, 99 ~ 103 MHz (PV-C2580)

General

Power Source: 120 V AC, 60 Hz
Power Consumption: Approx. 130 watts (Power on)
Approx. 4.5 watts (Power off)

Television System: EIA Standard NTSC color
Speaker: 1 pieces (PV-C2540)

2 pieces (PV-C2580)
Operating Temperature: 5 °C ~ 40 °C (41 °F ~ 104 °F)
Operating Humidity: 10 % ~ 75 %

Weight: 31 Kg (68.2 lbs.)
Dimensions: 24-15/16" (W) X 23-1/4" (H) X 18-1/4" (D)

634 (W) X 590 (H) X 464 (D) mm

Note: Designs and specifications are subject to change without notice.

Before Requesting Service

Check the following points once again if you are having trouble with your unit.

Power	Correction
No power...	<ul style="list-style-type: none">• Completely insert Power Plug into an AC outlet.• Set POWER button to ON.
Monitor	Correction
No picture or sound...	<ul style="list-style-type: none">• Make sure your antenna system (TV or CABLE), is correctly set. (P. 7)• Completely insert Power Plug into an AC outlet.• Set POWER button to ON.
Poor picture with normal sound...	<ul style="list-style-type: none">• Adjust BRIGHTNESS, SHARPNESS, and PICTURE controls in the SET UP TV menu. (P. 37)
Poor sound with normal picture...	<ul style="list-style-type: none">• Adjust VOLUME control. (P. 10)
Poor TV reception...	<ul style="list-style-type: none">• Adjust SHARPNESS and PICTURE controls in the SET UP TV menu. (P. 37)
No color or poor color...	<ul style="list-style-type: none">• Adjust TINT and COLOR controls in the SET UP TV menu. (P. 37)
Ghost (multiple) images...	<ul style="list-style-type: none">• Install a directional antenna.
TV programs cannot be watched...	<ul style="list-style-type: none">• Make sure the selected channel is in unit's memory. (P. 46)
Channel cannot be selected...	<ul style="list-style-type: none">• Only the channel being recorded can be viewed on this unit.
VCR	Correction
TV program cannot be recorded...	<ul style="list-style-type: none">• Make sure your antenna system (TV or CABLE), is correctly set. (P. 7)• Make sure cassette record tab is intact. (P. 6)
Timer recording cannot be performed...	<ul style="list-style-type: none">• Check that clock is set to current time and date.• Make sure DSS/CABLE box (if used) is left on and tuned to channel to be recorded.• Set recording Start/Stop time correctly. (P. 14, 15)• Timer recording may not be performed or continued if a power interruption of more than 1 minute occurs before or during a Timer recording even after power is restored.
No playback picture, or the playback picture is noisy or contains streaks... VCR cannot be controlled...	<ul style="list-style-type: none">• Adjust TRACKING control in either direction. (P. 12)• Try Head Cleaning. (P. 48)• Make sure VCR LOCK is set to off. (P. 32)• Make sure unit is not in a Timer Record operation.
Remote Control	Correction
Unit cannot be controlled...	<ul style="list-style-type: none">• Aim remote at remote sensor on unit (P. 55) so that signal is unobstructed.• Inspect the remote batteries. (P. 6)• Make sure VCR LOCK is set to off. (P. 32)• Exposing unit remote sensor to direct fluorescent or outdoor light may cause signal interference.
ACTION, PROG/VCR+ and FM/TV buttons cannot be selected...	<ul style="list-style-type: none">• Press COMBO button for COMBO mode. (P. 42)• Check remote batteries.
Miscellaneous	Correction
Video cassette cannot be inserted...	<ul style="list-style-type: none">• Insert the cassette window side up; record tab facing you.
Video cassette cannot be removed...	<ul style="list-style-type: none">• Completely insert Power Plug into an AC outlet.
Tape cannot be ejected or inserted...	<ul style="list-style-type: none">• Try ejecting or inserting the tape again after turning POWER off, then back on.
Video cassette ejects when a recording is started, or the power is turned off for timer recording...	<ul style="list-style-type: none">• Make sure cassette record tab is intact. (P. 6)
In Stop mode, the VCR motor (CYLINDER) continues to rotate...	<ul style="list-style-type: none">• To enable Quick Play mechanism, the VCR cylinder will rotate for about 5 minutes. This reduces response time from Stop to Play mode and from Play to Rewind Search mode.
VCR cannot be controlled...	<ul style="list-style-type: none">• Make sure VCR LOCK is set to off. (P. 32)

If you cannot resolve the problem, please call the Customer Satisfaction Center for product assistance at 201-348-9090.

To locate an authorized servicer call toll free 1-800-211-PANA(7262.)

Service Center List

For Product Information, Operating Assistance, Literature Request, Dealer Locations, and all Customer Service inquiries please contact:
1-800-211-PANA (7262), Monday-Friday 9 am-9 pm Saturday-Sunday 9 am-7 pm, EST.

Web Site: <http://www.panasonic.com>
You can purchase parts, accessories or locate your nearest servicenter by visiting our Web Site.

Accessory Purchases:

1-800-332-5368 (Customer Orders Only)
Panasonic Services Company 20421 84th Avenue South, Kent, WA 98032
(6 am to 5 pm Monday - Friday; 6 am to 10:30 am Saturday; PST)
(Visa, MasterCard, Discover Card, American Express, Check)

Factory Servicenters Locations

CALIFORNIA

6550 Katella Avenue
Cypress, CA 90630

800 Dubuque Avenue
S. San Francisco,
CA 94080

20201 Sherman Way
Suite 102
Canoga Park, CA 91306

3878 Ruffin Road
Suite A
San Diego, CA 92123

COLORADO

1640 South Abilene
Street Suite D
Aurora, CO 80012

FLORIDA

3700 North 29th Avenue
Suite 102
Hollywood, FL 33020

GEORGIA

8655 Roswell Road
Suite 100
Atlanta, GA 30350

ILLINOIS

9060 Golf Road
Niles, IL 60714

1703 North Randall
Road Elgin, IL 60123
(Pick-up / Drop-off only)

MARYLAND

62 Mountain Road
Glen Burnie, MD 21061

MASSACHUSETTS

60 Glacier Drive
Suite G
Westwood, MA 02090

MICHIGAN

37048 Van Dyke
Avenue
Sterling Heights,
MI 48312

MINNESOTA

7850-12th Avenue South
Airport Business Center
Bloomington, MN 55425

OHIO

2236 Waycross Road
Civic Center Plaza
Forest Park, OH 45240

PENNSYLVANIA

2221 Cabot Blvd
West Suite B
Langhorne, PA 19047

Chartiers Valley
Shopping Center
1025 Washington Pike
Bridgeville, PA 15017

TENNESSEE

3800 Ezell Road
Suite 806
Nashville, TN 37211

TEXAS

7482 Harwin Drive
Houston, TX 77036

13615 Welch Road
Suite 101
Farmers Branch,
TX 75244

WASHINGTON

20425-84th Avenue
South Kent, WA 98032

HAWAII

99-859 Iwaiwa Street
Aiea, Hawaii 96701
Phone (808) 488-1996
Fax (808) 486-4369

Service in Puerto Rico

Matsushita Electric of Puerto Rico, Inc. Panasonic Sales Company/ Factory Servicenter:
Ave. 65 de Infanteria, Km. 9.5. San Gabriel Industrial Park, Carolina, Puerto Rico 00985
Phone (787)750-4300 Fax (787)768-2910

As of October '99

Conexión de la antena externa

Desenganche la antena del televisor o de la videograbadora que tuviera anteriormente y conéctela a la parte trasera del registrador Combinación de VCR/TV, como se muestra en el diagrama. Si el sistema de su antena tiene conductores UHF y VHF separados, usted necesita un mezclador de banda UHF/VHF (no viene con el equipo.)

ADVERTENCIA:

Al utilizar cables coaxiales RF del "Tipo tuerca", solo debe apretarse con los dedos. Si se aprieta demasiado los cables pueden resultar dañados.

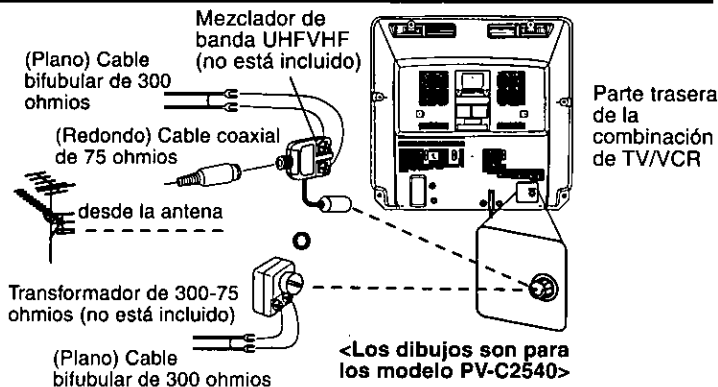

Conexiones de TV cable

■ Sin un decodificador de TV cable

Podrá;

- grabar o ver canales sin codificar.

No Podrá;

- grabar o ver canales codificados.
- ver otro canal que no sea el seleccionado para cualquier tipo de grabación.

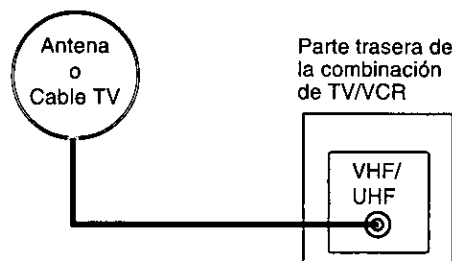

■ Con un decodificador de TV cable

Podrá;

- grabar o ver cualquier canal incluso los canales codificados.

NOTA : El canal deberá ser seleccionado en el decodificador de TV cable.

No Podrá;

- ver otro canal que no sea el seleccionado para cualquier tipo de grabación.
- hacer una grabación con temporizador de un canal a menos que lo seleccione en el decodificador de TV cable.

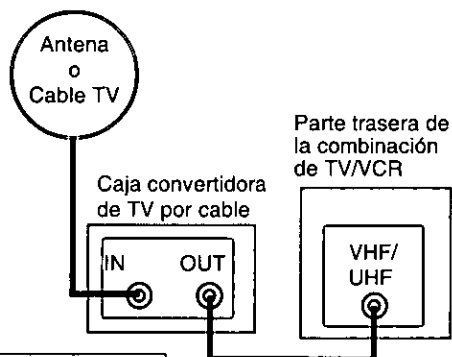

Para ver y grabar un canal codificado/ no codificado

Sintonice el canal del Registrador de la combinación de TV/VCR en el canal de salida de la caja convertidora de televisión por cable (por ejemplo el canal 3.)

Después, seleccione en el decodificador de TV cable el canal que se quiera ver o grabar.

■ Con un receptor DSS

Podrá;

- grabar o ver cualquier canal incluso los canales codificados.

NOTA : El canal deberá ser seleccionado en el receptor DSS.

No Podrá;

- ver otro canal que no sea el seleccionado para cualquier tipo de grabación.
- hacer una grabación con temporizador de un canal a menos que lo seleccione en el receptor DSS.

NOTA : El receptor DSS debe estar apagado para ver programas desde un decodificador de TV cable o desde la antena.

Consulte el manual del receptor DSS para más detalles.

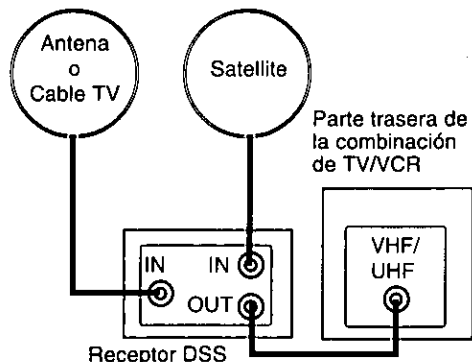

Para fijar el idioma, canal y reloj

1 Presione **POWER** para encender el videograbador combinado.

2

SELECT LANGUAGE

PUSH CH ▲ : English
OPRIMIR CH ▼ : Español
APP. VOL + : Français

Seleccione el lenguaje.

CH : para inglés
CH : para español
VOL+: para francés

3

FIJACION AUTO. (CA/RELOJ)

CONECTE EL CABLE DE LA ANTENA Y SI ESTA USANDO UNA CAJA DE TV POR CABLE SINTONICE AL CANAL PBS DE SU LOCAL. LUEGO...
POR FAVOR OPRIMIR CH UP

Comience el ajuste automático de canales y el ajuste automático del reloj.

Presione CH ▲.

Las siguientes informaciones aparecerán seguidamente:

- AUTOPROGRAMACION EN PROCESO
- AUTOPROGRAMACION COMPLETO
- FIJACION AUTOMATICA DEL RELOJ EN PROCESO

Caso 1

6/7/2000 MIE 12:00PM
HORA VERANIEGA: ACT
CANAL FIJADO : CA 10
FIJACION AUTOMATICA
COMPLETO
TERMINAR : OPRIMIR CH UP

(Ajuste terminado)

Presione CH ▲ para salir.

- Si la hora exhibida no es la correcta para su zona, ajuste el reloj nuevamente de acuerdo con la sección "Ajuste de la zona horaria" en la siguiente página.

Caso 2

FIJACION AUTOMATICA DEL RELOJ ES INCOMPLETO
OPRIMIR ACTION PARA FIJAR EL RELOJ

(Ajuste sin terminar)

NOTA IMPORTANTE PARA AJUSTE AUTOMATICO DEL RELOJ

- El ajuste automático del reloj será realizado al volver a encender el videograbador combinado cada vez que lo apague. Si usa un decodificador de TV cable y desea que la función de ajuste automático del reloj funcione, el decodificador de TV cable debe quedar encendido y sintonizando el canal PBS en el momento en que se apaga el videograbador combinado.
- Si usa un sintonizador de TV satelital, para que funcione el ajuste automático del reloj, debe de estar apagado.
- Si usa un toma de audio/video para conectar el videograbador combinado y el decodificador de TV cable o el sintonizador de TV satelital, deberá también conectar el cable coaxial RF para poder usar las funciones de ajuste automático de reloj y ajuste automático de canal.
- Si por cualquier razón se cambiara la hora manualmente, no se podrá realizar la corrección automática de la hora.

Caso 1 Ajuste de la zona horaria.

A Exhiba el **MENU PRINCIPAL**.
Presione **ACTION**.

B

MENU PRINCIPAL

TV
CANAL

VCR
RELOJ

IDIOMA
SALTR

ELEGIR: ▲ ▼ ◀ ▶
FIJAR : ACTION

Exhiba la pantalla "FIJAR RELOJ."

- 1) Presione ▲▼◀▶ para seleccionar "RELOJ."
- 2) Presione ACTION para exhibirla.

C

FIJAR RELOJ

FIJACION AUTOMATICA
MANUAL
AJUSTE ZONA HORA : 0

ELEGIR: ▲ ▼
FIJAR : ◀ ▶
TERMINAR: ACTION

Seleccione "AJUSTE ZONA HORA."

- 1) Presione ▲▼ para seleccionar.
- 2) Presione ◀▶ para ajustar.

D Final del ajuste.
Presione **ACTION** dos veces.
• El valor numérico ajustado aquí se vuelve "0" una vez que ajuste manualmente el reloj.

Caso 2 El ajuste del reloj es incompleto. Ajuste el reloj manualmente.

a

FIJACION AUTOMATICA DEL RELOJ ES INCOMPLETO

OPRIMIR ACTION PARA FIJAR EL RELOJ

Exhiba la pantalla **FIJAR RELOJ**.
Presione **ACTION** para salir de este modo.

b

FIJAR RELOJ

VERANO: ACT

ELEGIR MES

ELEGIR: ▲ ▼
FIJAR : ▶
TERMINAR: ACTION

Ajuste el reloj manualmente.

- 1) Presione ▲▼ para seleccionar el mes.
- 2) Presione ▶ para ajustar.

- De la misma manera, ajuste el día, el año, la hora y la hora de ahorro de energía. (VERANO)

Para hacer correcciones, presione repetidamente ◀▶ para moverse hasta el error, luego corríjalo.

C Final del ajuste.
Presione dos veces **ACTION**.

Para fijar o fijar de nuevo el reloj

En caso de que el reloj es incorrecto o ha ocurrido un corte eléctrico.

- 1 Oprima **ACTION** para que parezca el **MENU PRINCIPAL**.
- 2 Oprima ▲▼◀▶ para elegir "RELOJ." Luego, oprima **ACTION** para que aparezca la pantalla de la **FIJAR RELOJ**.
- 3 Oprima ▲▼ para elegir "MANUAL," y luego ▶ para que aparezca la pantalla de la **FIJAR RELOJ**.
- 4 Por favor continúe con los pasos **b** y **c** de la instrucción anterior (Caso 2.)

Operaciones básicas para la reproducción

- 1 Inserte un casete.**
 - El videograbador combinado se enciende automáticamente.
- 2 Presione PLAY.**
 - La reproducción comienza automáticamente si el casete no tiene la lengüeta para prevención de grabación.
 - Para encontrar una escena en particular Búsqueda hacia adelante → Presione FF Búsqueda hacia atrás → Presione REW
 - Para ver una imagen fija (congelada) → Presione PAUSE/SLOW
 - Para ver en cámara lenta → Mantenga pulsado el botón PAUSE/SLOW en el modo de imagen fija
 - Para ver imágenes cuadro a cuadro → Presione PAUSE/SLOW en el modo de imagen fija
 - Para parar → Presione STOP
 - Para rebobinar la cinta → Presione REW
 - Para hacer avanzar la cinta rápidamente → Presione FF
 - Para expulsar la cinta → Presione EJECT en el control remoto o STOP/EJECT en el videograbador combinado

Operaciones básicas para la grabación

- 1 Inserte un casete con la lengüeta para prevención de grabado.**
 - El videograbador combinado se enciende automáticamente.
- 2 Seleccione el canal.**

Presione CH ▲▼ o las teclas numéricas correspondiente.
- 3 Seleccione la velocidad de grabación.**

Presione SPEED.

SP = reproducción normal
LP = reproducción larga
SLP = reproducción super larga

 - La velocidad seleccionada debe aparecer en la pantalla.
- 4 Comience la grabación.**

Presione REC.

 - Para editar partes no deseadas de una grabación, presione PAUSE/SLOW para hacer una pausa durante la grabación.
 - No podrá ver otro canal durante la grabación.
 - Para parar → Presione STOP.
 - **El videograbador combinado deja de grabar a una hora prefijada.** (Grabación de un toque)
Presione REC repetidamente para ajustar la hora de grabación (30 min - 4 horas.)

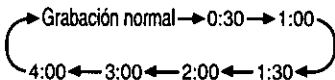

Grabación con temporizador

- 1 Exhiba FIJAR PROGRAMACION.**
Presione PROG/VCR+.
- 2 Exhiba TEMPORIZADOR.**

FIJAR PROGRAMACION

VCR Plus+
TEMPORIZADOR
ENCENDIDO AUTOMATICO

ELEGIR: ▲ ▼
FIJAR: ►
TERMINAR: PROG

 - 1) Presione ▲▼ para seleccionar.
 - 2) Presione ► para exhibir.
 - Si ya existe un programa en la memoria, presione ▲▼ y ► para seleccionar un número de programa sin usar.
- 3 Ajuste la fecha de grabación.**

FECHA INICIO PARADA CA

7 WE ---:--:--:--

HOY/IN

CATEGORIA:NO SLP

ELEGIR FECHA DE INICIO

ELEGIR: ▲ ▼
FIJAR: ►
TERMINAR: PROG / ACTION

 - 1) Presione ▲▼ para seleccionar.
 - 2) Presione ► o ◀ para ajustar.

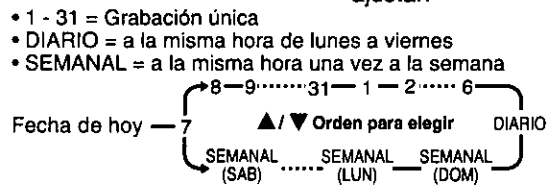

Repita el paso 3 para ajustar: hora de comienzo, hora de parada, canal (o LINEA para una fuente exterior), categoría [N/O (no aplicable), DEPORTE, CINE, COMEDIA, MUSICA, DRAMA], velocidad (SP, LP, SLP)

- 4 Haga las anotaciones necesarias.**
 - Si no fueran necesarias, vaya al paso 5.
- 1) Presione ▲ para hacerlas.
- 2) Presione ▲▼ para seleccionar.
- Los caracteres cambiarán en el siguiente orden.
- 3) Presione ► o ◀ para ajustar.
- 4) Presione PROG/VCR+ para finalizar.

- 5 Termine el programa.**
Presione PROG/VCR+ (o ACTION.)
Para introducir más programas.
presione ▲▼ y ► para seleccionar y ajustar el número de programa en blanco, y luego repita los pasos 3 y 4.
- P FE INIC PARADA CA VEL

1 DI 9:00p 12:00a 06 SP

2 ---:--:--:--

3 ---:--:--:--

4 ---:--:--:--

CANCELAR: ADD/DLT
ELEGIR 1-8: ▲ ▼
ENTRAR: ►
TERMINAR: PROG / ACTION

- 6 Salga de este modo.**
Presione PROG/VCR+ dos veces (o ACTION.)
 - Si está usando un decodificador de TV cable, asegúrese que se encuentra en el canal deseado y que la alimentación queda conectada para grabar con temporizador.
 - El indicador PROG TIMER se enciende en el videograbador combinado.

Location of Controls

Remote Control Buttons

Light Tower™ Illuminated Remote Control

LIGHT button:

When the LIGHT button is pressed, the buttons which can be activated in the selected mode will light and the selected mode button (COMBO or DSS CABLE) will flash for 5 seconds. If no buttons are pressed within 5 seconds, the light will turn off in order to conserve battery power. Also, while holding down the buttons, the selected mode button will flash so you will be able to see, in the dark, which mode has been selected.

EJECT button:

When EJECT is pressed, the tape is ejected from Cassette Compartment. If EJECT is pressed during recording, the unit will not respond to the command.

EJECT

Page 12.

COMBO

Page 42.

POWER

Page 8.

LIGHT

Page 54.

FM/TV

Page 34.

DSS CABLE

Page 42.

MUTE

Page 10.

RAPID TUNE

Page 10.

CHANNEL UP/DOWN

Page 10.

SELECT UP/DOWN

Page 9.

VOLUME UP/DOWN

Page 10.

SET/BACKSPACE

Page 9.

ACTION

Page 46.

PROGRAM

Page 14.

VCR Plus+

Page 19.

NUMBERED KEYS

Page 10.

TRACKING UP/DOWN

Page 12.

REWIND/SEARCH

Page 12.

ADD/DELETE

Page 46.

PAUSE/SLOW

Page 12.

PLAY

Page 12.

CM SKIP

Page 24.

FAST FORWARD/SEARCH

Page 12.

SLEEP

Page 21.

ENTER DISPLAY

Page 47.

AUDIO (Available for Model PV-C2580 only)

Page 11.

STOP

Page 12.

NITE

Page 10.

TAPE POSITION

Page 24.

SPEED

Page 13.

REC

Page 13.

SEARCH

Page 24.

Model PV-C2580 remote is shown here.

COUNTER RESET

Page 25.

Front View of the unit and Indicators on the Front Panel

Model PV-C2540 unit is shown here.

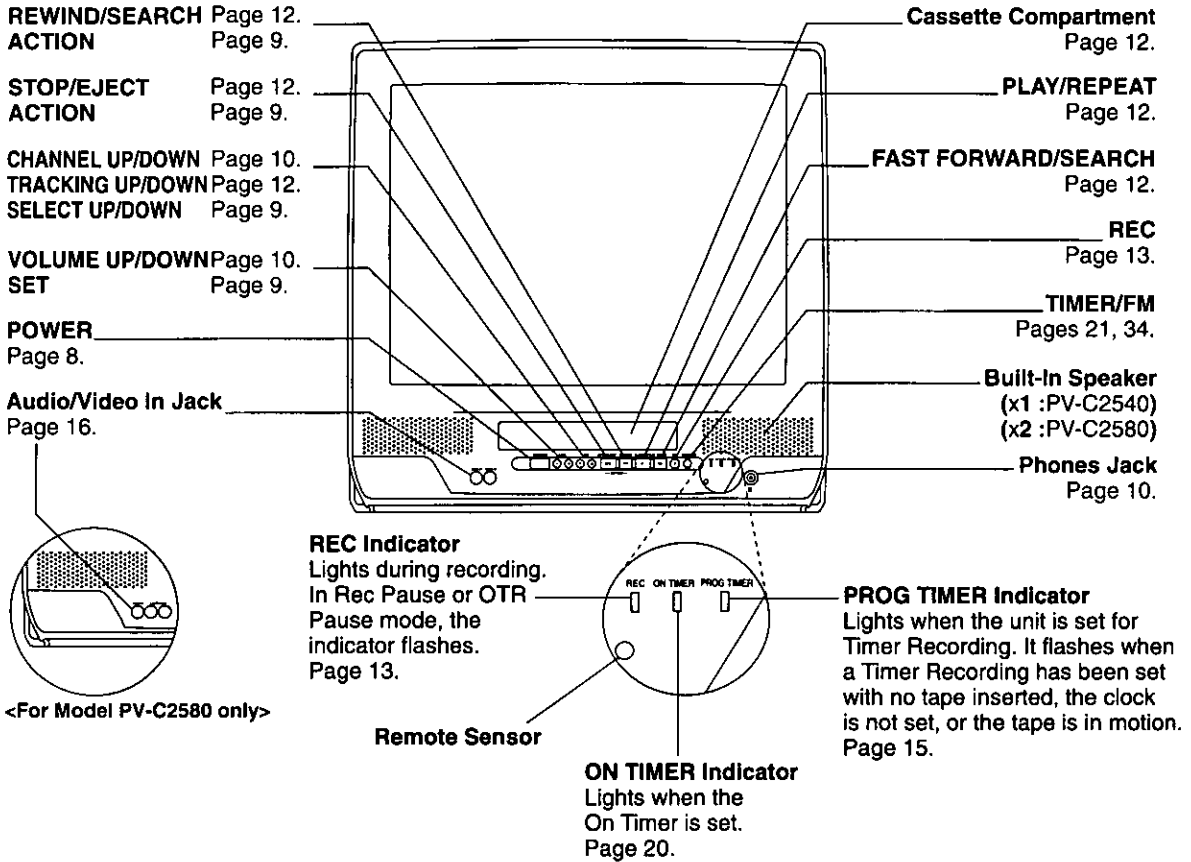

Rear View of the unit

Model PV-C2580 unit is shown here.

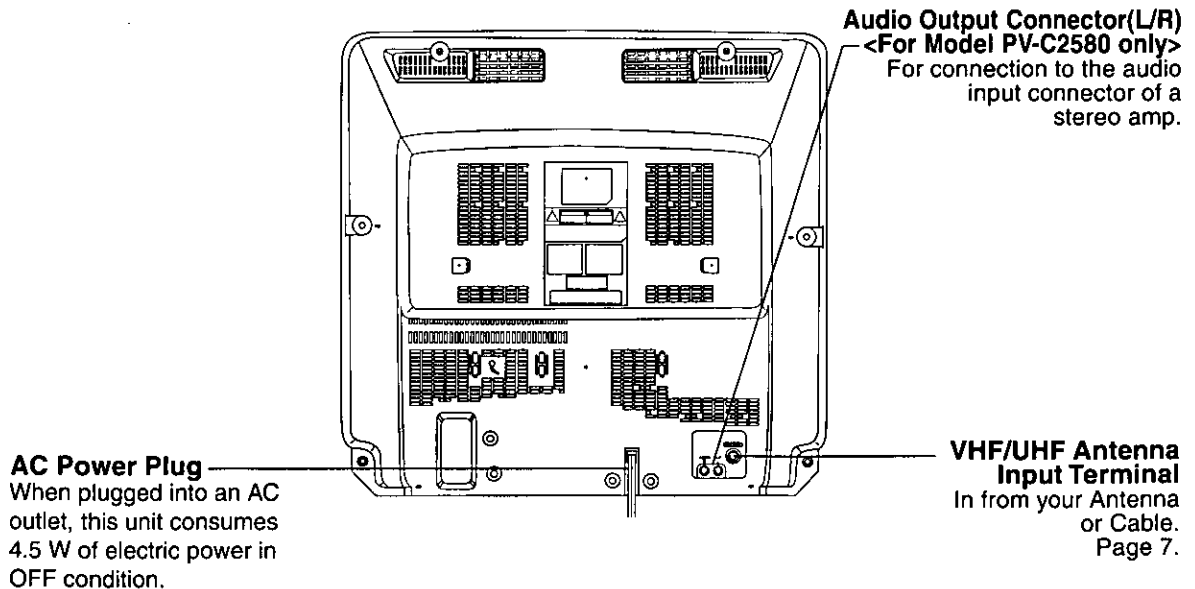

Warranty

Panasonic Consumer Electronics Company,
Division of Matsushita Electric Corporation of America,
One Panasonic Way
Secaucus, New Jersey 07094

Panasonic Sales Company,
Division of Matsushita Electric of Puerto Rico, Inc.
AVE. 65 de Infanteria, Km. 9.5 San Gabriel
Industrial Park Carolina, Puerto Rico 00985

PANASONIC Video Products Limited Warranty

Panasonic Consumer Electronics Company or Panasonic Sales Company (collectively referred to as "the Warrantor") will repair this product with new or refurbished parts, free of charge, in the USA or Puerto Rico, in the event of a defect in materials or workmanship as follows (all time periods commence from the date of the original purchase):

<u>PRODUCT</u>	<u>PARTS</u>	<u>LABOR</u>
CAMCORDER	ONE (1) YEAR, EXCEPT CCD IMAGE SENSOR CCD IMAGE SENSOR - SIX (6) MONTHS	NINETY (90) DAYS NINETY (90) DAYS
VCR	ONE (1) YEAR	NINETY (90) DAYS
AV MIXER	ONE (1) YEAR	NINETY (90) DAYS
MONITOR-VCR	ONE (1) YEAR, EXCEPT CRT CRT - TWO (2) YEARS	NINETY (90) DAYS CRT - NINETY (90) DAYS CUSTOMER PAYS ALL LABOR CHARGES AFTER 90 DAYS

Monitor-VCR In-home or carry-in Service: 22" (diagonal) CRT / LCD and Larger Monitor-VCR Carry-in Service: 21" (diagonal) CRT / LCD and smaller

Batteries (if included) - New rechargeable batteries in exchange for defective rechargeable batteries for ten (10) days. Non-rechargeable batteries are not warranted.

Tape (if included) - New video cassette tape in exchange for a defective video cassette tape for five (5) days. In-home, carry-in or mail-in service, as applicable, in the USA can be obtained during the warranty period by contacting a Panasonic Services Company (PASC) Factory Servicenter listed in the Service Directory. Or call toll free 1-800-211-PANA (7262), to locate an authorized PASC Servicenter. Carry-in or mail-in service in Puerto Rico can be obtained during the warranty period by calling the Panasonic Sales Company telephone number listed in the Servicenter Directory.

This warranty is extended only to the original purchaser. A purchase receipt or other proof of the date of the original purchase is required before warranty service is rendered.

This warranty only covers failures due to defects in materials and workmanship which occur during normal use and does not cover normal maintenance, including, but not limited to, video and audio head cleaning. The warranty does not cover damage which occurs in shipment, or failures which are caused by products not supplied by the warrantor, or failures which result from accident, misuse, abuse, neglect, mishandling, misapplication, alteration, modification, faulty installation, set-up adjustments, improper antenna, inadequate signal pickup, maladjustment of consumer controls, improper operation, power line surge, improper voltage supply, lightning damage, commercial use such as hotel, office, restaurant, or other business or rental use of the product, or service by anyone other than a PASC Factory Servicenter or a PASC authorized Servicenter, or damage that is attributable to acts of God.

LIMITS AND EXCLUSIONS

There are no express warranties except as listed above.

THE WARRANTOR SHALL NOT BE LIABLE FOR INCIDENTAL OR CONSEQUENTIAL DAMAGES (INCLUDING, WITHOUT LIMITATION, DAMAGE TO TAPES) RESULTING FROM THE USE OF THIS PRODUCTS, OR ARISING OUT OF ANY BREACH OF THE WARRANTY. ALL EXPRESS AND IMPLIED WARRANTIES, INCLUDING THE WARRANTIES OF MERCHANTABILITY AND FITNESS FOR PARTICULAR PURPOSE, ARE LIMITED TO THE APPLICABLE WARRANTY PERIOD SET FORTH ABOVE.

Some states do not allow the exclusion or limitation of incidental or consequential damages, or limitations on how long an implied warranty lasts, so the above exclusions or limitations may not apply to you.

This warranty gives you specific legal rights and you may also have other rights which vary from state to state.

If a problem with this product develops during or after the warranty period, you may contact your dealer or Servicenter. If the problem is not handled to your satisfaction, then write to the Customer Satisfaction Center at the Panasonic Consumer Electronics Company address above.

SERVICE CALLS WHICH DO NOT INVOLVE DEFECTIVE MATERIALS OR WORKMANSHIP AS DETERMINED BY THE WARRANTOR, IN ITS SOLE DISCRETION, ARE NOT COVERED. COSTS OF SUCH SERVICE CALLS ARE THE RESPONSIBILITY OF THE PURCHASER.

warvid 10/20/99

Panasonic Consumer Electronics Company,
Division of Matsushita Electric Corporation of America
One Panasonic Way Secaucus,
New Jersey 07094

Panasonic Sales Company,
Division of Matsushita Electric of
Puerto Rico, Inc. ("PSC")
Ave. 65 de Infanteria. Km. 9.5
San Gabriel Industrial Park, Carolina,
Puerto Rico 00985



Printed in U.S.A
LSQT0199A
S0100-0